



Quality Assurance Statement

The satisfaction of all customers is the fundamental principle of the GROZ corporate philosophy.

GROZ stands committed to the quality of its products and service with the assurance of complete back-up support.

With a wide range of products, prompt service and vast experience, GROZ remains dedicated to the customer.





INSIDE

GREASING EQUIPMENT

GREASE GUNS

- 7 Lever Grease Guns - Heavy Duty
- 8 Lever Grease Gun - Professional
- 9 Lever Grease Guns - Super Value
- 10 Lever Grease Guns – Standard
- 11 Lever Grease Gun - "V" Series
- 12 Lever Oil Gun
- 13 Lever Grease Gun - Japanese Style
- 14 Double Lever Grease Gun
- 15 Pistol Grip Grease Gun - Professional
- 16 "Vario" Premium Pistol Grip Grease Guns
- 17 Dual Discharge Pistol Grip Grease Gun
Ultimate' All Weather Pistol Grip Grease
Guns
- 18 Pistol Grip Grease Guns
- 20 Pistol Grip Grease Guns
- 21 Pistol Grip Grease Gun - V Series
- 22 Quick Connect Pistol Grip Grease Gun
- 24 Clear Tube Lever Grease Gun
- 25 Clear Tube Pistol Grip Grease Gun
- 26 Mini Lever Grease Gun
- 26 Push Type Grease Guns
- 27 Mini Pistol Grease Gun - Deluxe
- 27 Mini Pistol Grease Guns - Popular
- 28 Air Operated Grease Guns
- 30 High Power Air Operated Grease Gun
- 31 19.2V Battery Powered Grease Gun

GREASE GUN ACCESSORIES

- 32 Hydraulic Couplers & Sets
- 34 Hydraulic Couplers - Heavy Duty
- 34 Hydraulic Coupler - AIR-O
- 35 Hydraulic Couplers - 90°
- 35 Hydraulic Couplers - 360°
- 36 Button Head Couplers
- 37 Hydraulic Couplers - Pin Type
- 37 Needle Nose Dispensers
- 38 Grease Injector Needles
- 38 Seal Off Dispenser
- 39 Grease Gun Holders
- 39 Heavy Duty Grease Gun Holder

- 40 Grease Gun Hoses
- 42 Grease Gun Hoses – Heavy Duty
- 44 Flexible/Rigid Grease Gun Extension
- 44 Grease Gun Extension Swivel
- 45 Grease Gun Steel Extensions
- 45 Grease Gun Light
- 46 Bulk Loaders / Filler Nipples
- 46 Air Release Valves
- 47 Deluxe Steel Bearing Packers

GREASE FEEDERS

- 48 Grease Feeders

GREASE FITTINGS & ACCESSORIES

- 50 Grease Fittings
- 52 Grease Fitting Sets
- 54 Greasing Adaptors & Elbows
- 54 Grease Fitting Thread Tester
- 55 Grease Fitting Caps
- 55 Easy Out Tools
- 56 "Drive Fit" Grease Fitting Installer
- 56 Grease Fitting Unblocker

QUICK LINK

- 57 Quick Connect Adaptors
- 60 Quick Disconnect Adaptor
- 60 Ezee Lube Kit

GREASE PUMPS & ACCESSORIES

- 61 Composite Air Operated Grease Ratio
Pumps 50:1
- 62 Air Operated Grease Ratio Pumps 50:1
- 64 Grease Control Valves – Professional
- 65 Grease Control Valves – Booster
- 66 Grease Control Valves – Metered
- 67 High Pressure Grease Swivels
- 68 Foot Operated Grease Pump
- 69 Portable Greasing System
- 70 Bucket Greasers
- 72 Grease Filler Pump - Professional
- 73 Grease Filler Pumps
- 74 High Pressure Grease Pumps
- 75 Follower Plates
- 76 Female Loader Adaptors

OILING EQUIPMENT

OIL PUMPS & ACCESSORIES

- 78 Lever Action Barrel Pumps
- 79 Lever Action Oil Pump
- 79 Vertical Lift Pump
- 80 Front Action Barrel Pump
- 81 Quart / Litre Stroke Pump
- 82 Rotary Barrel Pumps
- 83 Rotary Barrel Pump - Professional
- 84 Rotary Booster Pump 3:1
- 85 Double Diaphragm Fuel Transfer Pump
- 86 Industrial Rotary Barrel Pumps
- 88 Oil Lube Dispensers
- 89 Spring Loaded Pumps
- 90 Ezee Flo Pump
- 91 Drip Pans
- 91 Bung Nuts
- 92 Suction Tubes
- 93 Composite Air Operated Oil Pum - 5:1
- 94 Air Operated Oil Ratio Pumps
- 96 Air Operated Stainless Steel Pump
- 97 Air Operated Oil Pump Accessories
- 98 Air Operated Double Diaphragm Pumps
- 100 Electric Oil & Fuel Pump

OIL METERS & GUNS

- 102 Electronic Oil Meters
- 103 Mechanical Oil Meters
- 104 Electronic Oil Control Guns
- 105 Mechanical Oil Control Guns
- 106 Electronic Preset Oil Control Gun
- 107 Oil Control Guns
- 108 Oil Control Gun Accessories

OIL PUMP ACCESSORIES

- 109 Oil Spigots
- 110 Suction Guns
- 111 Transfer Gun

OIL CANS & ACCESSORIES

- 112 Oil Cans
- 114 Speciality Oil Cans
- 114 Flexible & Rigid Spouts

OIL MEASURES & FUNNELS

- 115 Flexible Spout Measures
- 116 Smart Funnels

HOSE REELS

- 118 AIR WATER -LOW PRESSURE HOSE REELS
- 118 OIL - MEDIUM PRESSURE HOSE REELS
- 118 GREASE - HIGH PRESSURE HOSE REELS

WASTE OIL HANDLING

- Air Operated Double Diaphragm Waste Oil Pumps
- 121 Waste Oil Drain - Pressurized
- 122 Waste Oil Drain - Gravity Feed
- 123 Electric Oil Pump
- 124 Low Profile Truck Drain
- 125 Drain Pans

SPECIALITY PUMPS

- 128 Diaphragm / Bilge Pump
- 129 Diaphragm Pump - Food Grade
- 130 Plastic Lever Pump
- 131 Air Operated DEF Transfer Pump
- 132 Plastic Rotary Pumps
- 134 Polypropylene Chemical Pump
- 134 Nylon Chemical Pump
- 135 Siphon Pumps

- 136 Battery Operated Plastic Pump

- 136 Tire Sealant Pump
- 137 Brass Transfer Pumps
- 138 Safety Pumps

AIR LINE

- 141 Air Regulator
- 141 Air Lubricator
- 142 Filter Regulator Combination
- 142 Filter-Regulator & Lubricator - 2 pc
- 143 Air Coupler & Nipple
- 144 Air Line Fittings

DRUM HANDLING

- 146 Drum Dolly
- 146 Drum Dolly - Stainless Steel
- 147 Band Dollies
- 148 Cross brace Lip Dolly
- 148 Drum Wrench
- 149 Drum Cradle
- 150 Low Profile Drum Trolley
- 150 Drum Trolley - Adjustable
- 151 Drum Faucet / Tap
- 151 Drum Bung Converter

WE ARE
CONTINUALLY
EVOLVING...

Over the last four decades, Groz has imposed an unrivalled quality standard in the manufacturing of Lubrication Equipment. This search for excellence is what drives 'TEAM GROZ'. Wherever you deploy your business, whatever your application, we provide you with the best equipment you need.

OUR
PRODUCTS
FIND APPLICATION IN A
VARIETY OF INDUSTRIES



MARINE



WOODWORKING



CONSTRUCTION



ENERGY & POWER



DIY



AEROSPACE & DEFENCE



MINING



INDUSTRIAL & MACHINERY



AUTOMOTIVE



AGRICULTURE



RAILROAD



WORKSHOP



OIL & GAS



CEMENT & STEEL

GREASING

equipment

'Engineering end to end Greasing Solutions'
A host of new grease guns & pumps suited
to every possible application!

NEW PRODUCTS to look out for

- 12 LEVER OIL GUN

- 13 LEVER GREASE GUN - JAPANESE STYLE

- 14 DOUBLE LEVER GREASE GUN

- 17 DUAL DISCHARGE PISTOL GRIP GREASE GUN

- 18 ULTIMATE ALL WEATHER PISTOL GRIP GREASE GUN

- 22 QUICK CONNECT PISTOL GRIP GREASE GUN

- 24 CLEAR TUBE LEVER GREASE GUNS

- 25 CLEAR TUBE PISTOL GRIP GEASE GUNS

- 26 MINI LEVER GREASE GUN

- 31 BATTERY OPERATED GREASE GUN

- 33 HYDRAULIC COUPLER - PROFESSIONAL - SLIM

- 45 GREASE GUN LIGHT

- 48 GREASE FEEDERS

- 54 GREASING ADAPTORS & ELBOWS

- 66 GREASE CONTROL VALVES - METERED

- 68 FOOT OPERATED PUMP



01

LEVER GREASE GUNS - HEAVY DUTY



AUTOMOTIVE



INDUSTRIAL

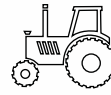

AGRICULTURE

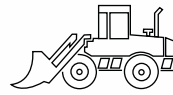

CONSTRUCTION

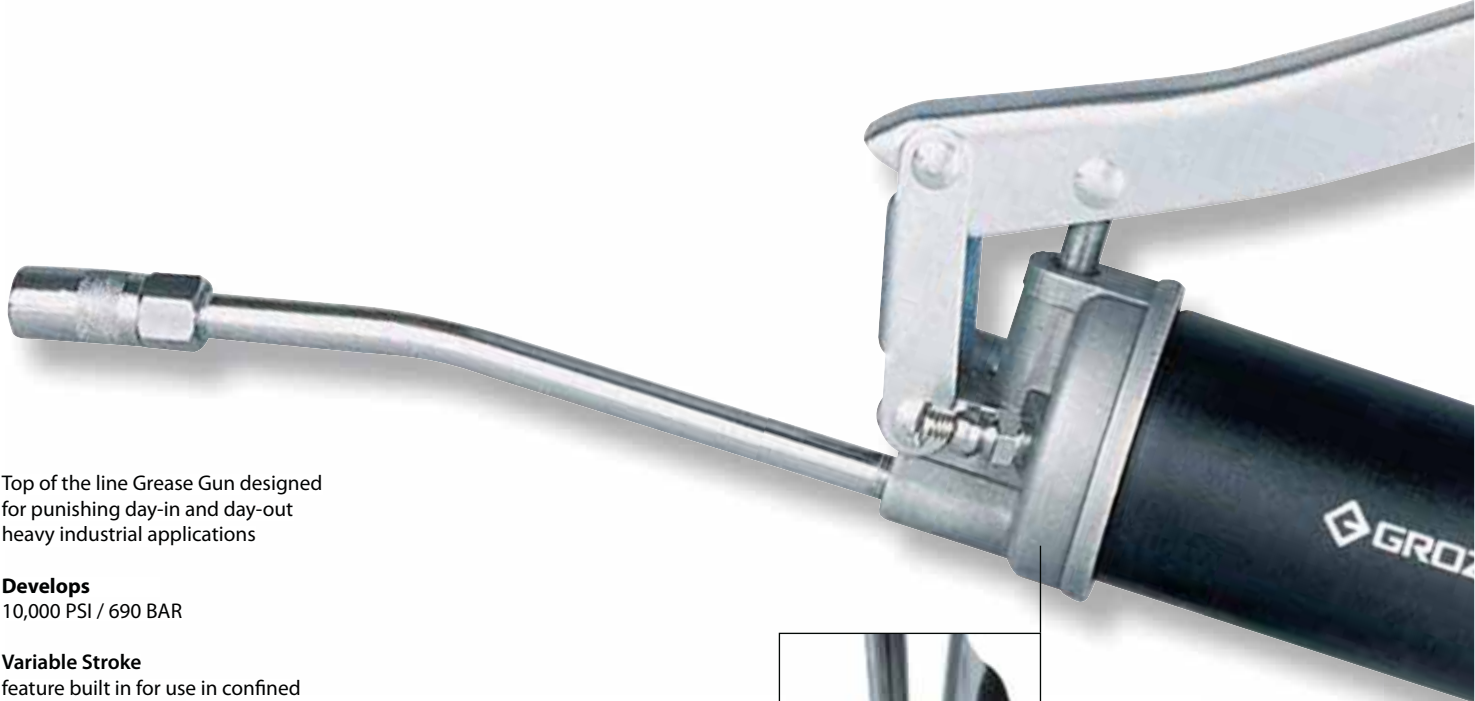

Top of the line Grease Gun designed for punishing day-in and day-out heavy industrial applications

Develops

10,000 PSI / 690 BAR

Variable Stroke

feature built in for use in confined areas

High Tolerance Aluminum Die Cast Grease Gun Head

Built Tough

Robust barrel 0.049 (1.2 mm) thick, Heavy Duty follower spring, CNC machined grease gun head, large rolled threads for fast & easy re-loading

Complete with a choice of 6" (150 mm) steel extension or 12" (300 mm) flexible hose & professional 4 jaw coupler with ball check



Heavy Duty Grease Gun Head incorporates a bulk loader and an air bleeder valve



G4-HD

For use with 450 gms grease cartridge, popular in Australia & New Zealand

∅ 63.5 mm



G10-HD

High Capacity Grease Gun for use with 24 oz. (750 cc) bulk grease or with standard 14 oz. (400 gms) grease cartridge

∅ 2-1/4" (57.15 mm)

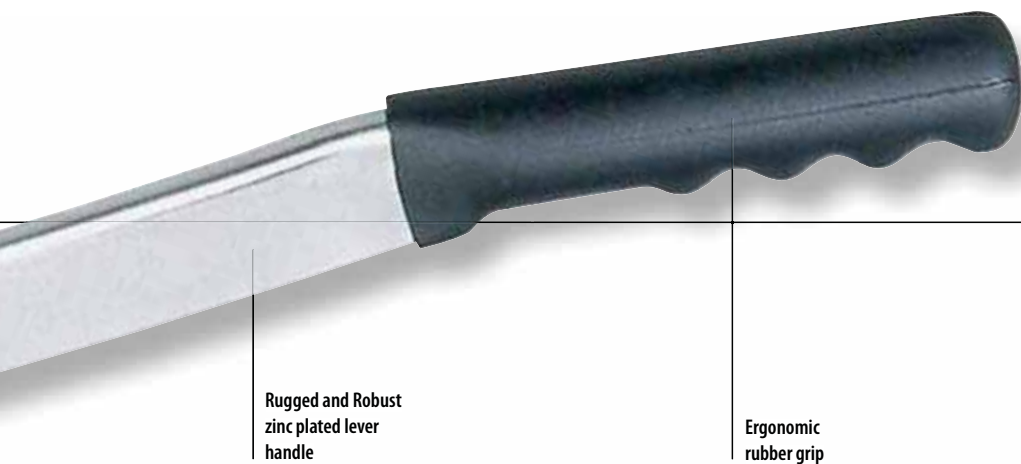

Rugged and Robust zinc plated lever handle

Ergonomic rubber grip

- G1-HD
- G4-HD
- G10-HD

DELIVERS 

Upto 1gm / stroke
Upto 1 oz. / 28 strokes

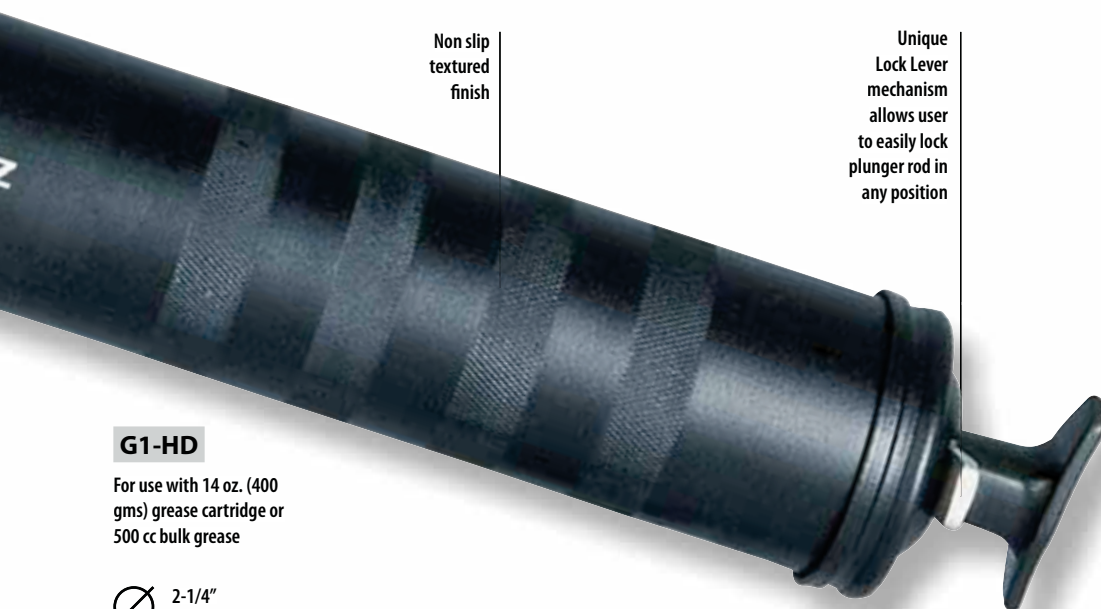







Non slip textured finish

Unique Lock Lever mechanism allows user to easily lock plunger rod in any position

G1-HD

For use with 14 oz. (400 gms) grease cartridge or 500 cc bulk grease

 2-1/4" (57.15 mm)

-  **10,000 PSI (690 BAR)**
-  **VARIABLE STROKE**
-  **CARTRIDGE LOADING**
-  **SUCTION FILL**
-  **FILLER PUMP LOADING**
-  **NO FALSE LUBRICATION**

Grease Gun can be custom manufactured with zinc head for use in underground mines

CAT. NR.	ORD. NR.	CAT. NR.	ORD. NR.	CARTRIDGE CAPACITY	BULK CAPACITY	THREADS
WITH STEEL EXTENSION & COUPLER		WITH FLEXIBLE HOSE & COUPLER				
* G1R/HD/B	42700	G1F/HD/B	42720	14 oz. (400gms)	500 cm ³	1/8" BSPT
* G1R/HD/M	42701	G1F/HD/M	42721	14 oz. (400gms)	500 cm ³	M10 X 1
* G1R/HD/N	42702	G1F/HD/N	42722	14 oz. (400gms)	500 cm ³	1/8" NPT
* G4R/HD/B	42780	G4F/HD/B	42785	450 gms	650 cm ³	1/8" BSPT
G10R/HD/B	42750	G10F/HD/B	42760	14 oz. (400gms)	750 cm ³	1/8" BSPT
G10R/HD/M	42751	G10F/HD/M	42761	14 oz. (400gms)	750 cm ³	M10 X 1
G10R/HD/N	42752	G10F/HD/N	42762	14 oz. (400gms)	750 cm ³	1/8" NPT

Key * Best Seller

02

LEVER GREASE GUN - PROFESSIONAL

G8



AUTOMOTIVE

Professional Grease Gun, ideal for use in automotive applications

Develops

8,000 PSI / 550 BAR

Variable Stroke

feature built in for use in confined areas

Built Tough

Robust barrel 0.049" (1.2 mm) thick, Heavy Duty Follower Spring, CNC machined grease gun head, large rolled threads for fast & easy re-loading

Capacity

14 oz. (400 gms) grease cartridge or 500cc bulk fill

Complete with a choice of 6" (150 mm) steel extension or 12" (300 mm) flexible hose & professional 4 jaw coupler with ball check



Soft rubber grip on lever handle for ease of operation

2-1/4" (57.15 mm)

Aluminum die cast grease gun head incorporates a bulk loader

Non slip textured powder coated finish

Unique Lock Lever mechanism allows user to easily lock plunger rod in any position

DELIVERS

Upto 1gm / stroke
Upto 1 oz. / 28 strokes



8,000 PSI (550 BAR)



VARIABLE STROKE



CARTRIDGE LOADING



SUCTION FILL



FILLER PUMP LOADING



NO FALSE LUBRICATION

CAT. NR.	ORD. NR.	CAT. NR.	ORD. NR.	THREADS
WITH STEEL EXTENSION & COUPLER		WITH FLEXIBLE HOSE & COUPLER		
G8R/B	42600	G8F/B	42620	1/8" BSPT
G8R/M	42601	* G8F/M	42621	M10 x 1
G8R/N	42602	G8F/N	42622	1/8" NPT

Key * Best Seller

03

LEVER GREASE GUNS - SUPER VALUE



AUTOMOTIVE

DIY



AGRICULTURE



MINING

G1

G4

G10

G11

By far the most popular grease gun for general purpose

Lubrication in automotive, workshop, agricultural & light industrial applications

Drop resistant steel head construction

Develops

6,000 PSI / 413 BAR

Air release either through loader fitting on the grease gun head or half turn of the head assembly

Soft rubber grip on lever handle for comfortable operation

Durable powder coated finish

Complete with a choice of 6" (150 mm) steel extension or 12" (300 mm) flexible hose & standard 4 jaw coupler with ball check

DELIVERS

Upto 1gm / stroke
Upto 1 oz. / 28 strokes



G1

For use with 14 oz. (400 gms) grease cartridge or 500-cc bulk grease

2-1/4" (57.15 mm)

G4

For use with 450 gms grease cartridge, popular in Australia & New Zealand

63.5 mm

G10

High Capacity Grease Gun for use with 24 oz. (750 cc) bulk grease or with standard 14 oz. (400 gms) grease cartridge

2-1/4" (57.15 mm)

G11

Extra Long & Very High Capacity Grease Gun for use with 1000 cc bulk grease or standard 14 oz. (400 gms) grease cartridge

2-1/4" (57.15 mm)

CAT. NR.	ORD. NR.	CAT. NR.	ORD. NR.	CARTRIDGE CAPACITY	BULK CAPACITY	THREADS
WITH STEEL EXTENSION & COUPLER		WITH FLEXIBLE HOSE & COUPLER				
* G1R/SLV/B	42500	G1F/SLV/B	42520	14 oz. (400gms)	500 cm ³	1/8" BSPT
G1R/SLV/M	42501	G1F/SLV/M	42521	14 oz. (400gms)	500 cm ³	M10 X 1
G1R/SLV/N	42502	G1F/SLV/N	42522	14 oz. (400gms)	500 cm ³	1/8" NPT
* G4R/B	42580	G4F/B	42585	450 gms	650 cm ³	1/8" BSPT
G10R/B	42590	G10F/B	42595	14 oz. (400gms)	750 cm ³	1/8" BSPT
G10R/M	42591	G10F/M	42596	14 oz. (400gms)	750 cm ³	M10 X 1
G11R/B	42560	G11F/B	42565	14 oz. (400gms)	1000 cm ³	1/8" BSPT
G11R/M	42561	G11F/M	42566	14 oz. (400gms)	1000 cm ³	M10 X 1

Key * Best Seller



6,000 PSI
(413 BAR)



CARTRIDGE
LOADING



SUCTION
FILL



FILLER PUMP
LOADING

04

LEVER GREASE GUNS - STANDARD



AUTOMOTIVE

DIY

G1-STD

G1-DC

G23

Hardworking entry level Grease Gun, designed for use in general lubrication and daily maintenance work

Head incorporates single vent hole with block nut

Develops

6,000 PSI / 413 BAR

Air release achieved through half turn of the head assembly

Durable powder coated finish

Capacity

14 oz (400 gms) grease cartridge or 500 cc bulk fill

Complete with a choice of 6" (150 mm) steel extension or 12" (300 mm) flexible hose & 4 jaw coupler with ball check



DELIVERS

Upto 1gm / stroke
Upto 1 oz. / 28 strokes



G1-STD

For use with 14 oz. (400 gms) grease cartridge or 500 cc bulk grease. Powder Coated Steel Head

2-1/4" (57.15 mm)



G1-DC

For use with 14 oz. (400 gms) grease cartridge or 500 cc bulk grease. Aluminum Die Cast Head

2-1/4" (57.15 mm)



G23

For use with 14 oz. (400 gms) grease cartridge or 500 cc bulk grease. Powder coated Aluminum Die Cast Head & Heavy Duty Lever handle

2-1/4" (57.15 mm)

CAT. NR.	ORD. NR.	CAT. NR.	ORD. NR.	THREADS
WITH STEEL EXTENSION & COUPLER		WITH FLEXIBLE HOSE & COUPLER		
Steel Head				
G1R/STD/B	42400	G1F/STD/B	42420	1/8" BSPT
G1R/STD/M	42401	G1F/STD/M	42421	M10 x 1
* G1R/STD/N	42402	G1F/STD/N	42422	1/8" NPT
Aluminum Die Cast Head				
G1R/STD/DC/B	42450	G1F/STD/DC/B	42470	1/8" BSPT
* G1R/STD/DC/M	42451	G1F/STD/DC/M	42471	M10 x 1
* G1R/STD/DC/N	42452	G1F/STD/DC/N	42472	1/8" NPT
Powder Coated Aluminum Die Cast Head				
G23R/B	42430	G23F/B	42440	1/8" BSPT
G23R/M	42431	G23F/M	42441	M10 x 1
* G23R/N	42432	G23F/N	42442	1/8" NPT

Key * Best Seller



6,000 PSI (413 BAR)



CARTRIDGE LOADING



SUCTION FILL

05



LEVER GREASE GUN - 'V' SERIES

V1

DIY



21st Century design – Ideal combination of superior quality & value price

Aluminum Die Cast head fitted with air release valve

Soft rubber grip on lever handle for comfortable operation

Develops

6,000 PSI / 413 BAR

Hi visibility orange powder coated finish

Capacity

14 oz (400 gms) grease cartridge or 500 cc bulk fill

Complete with a choice of 6" (150 mm) steel extension or 12" (300 mm) flexible hose & standard 4 jaw coupler with ball check

Automatic Air Release Valve

Soft rubber grip on lever handle for ease of operation

2-1/4" (57.15 mm)

Drop Resistant Steel Handle

DELIVERS



Upto 1gm / stroke
Upto 1 oz. / 28 strokes

CAT. NR.	ORD. NR.	CAT. NR.	ORD. NR.	THREADS
WITH STEEL EXTENSION & COUPLER		WITH FLEXIBLE HOSE & COUPLER		
* V1R/B	42900	V1F/B	42920	1/8" BSPT
* V1R/M	42901	V1F/M	42921	M10 x 1
V1R/N	42902	V1F/N	42922	1/8" NPT

Key * Best Seller



6,000 PSI (413 BAR)



CARTRIDGE LOADING



SUCTION FILL

06

LEVER OIL GUN

NEW!

G19



Heavy Duty Oil Gun handles flowable greases & light oils without leakage

Very useful for pumping glue in water proofing and other construction applications

High Quality CDW steel barrel with fully machined seam for leak proof operation

High tolerance aluminium die-cast head

Grease gun follower designed for use both with Oil & Grease

Capacity

14oz. (400gm) grease cartridge / 500 cc bulk

Variable Stroke

feature built in for use in confined areas

Develops

Upto 10,000 PSI / 690 BAR

Complete with a choice of 6" (150 mm) steel extension or 12" (300 mm) flexible hose & professional 4 jaw coupler with ball check

Rugged and robust zinc plated lever handle

Ergonomic rubber grip

Non slip textured powder coated finish

Ø 2-1/4" (57.15 mm)



DELIVERS

Upto 1gm / stroke
Upto 1 oz. / 28 strokes



10,000 PSI (690 BAR)



VARIABLE STROKE



CARTRIDGE LOADING



Suitable for grease & oil



SUCTION FILL



HAND FILL

CAT. NR.	ORD. NR.	CAT. NR.	ORD. NR.	THREADS
WITH STEEL EXTENSION & COUPLER		WITH FLEXIBLE HOSE & COUPLER		
G19R/B	42740	G19F/B	42745	1/8" BSPT
G19R/M	42741	G19F/M	42746	M10 X 1
G19R/N	42742	G19F/N	42747	1/8" NPT

07

LEVER GREASE GUN - JAPANESE STYLE

NEW!

G81



INDUSTRIAL



AGRICULTURE

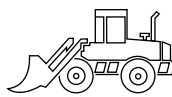

CONSTRUCTION

Professional Lever Grease Gun, ideal for use in Construction, Agricultural & Industrial applications

Develops

10,000 PSI / 690 BAR / 69 MPa

Built Tough

Robust Barrel 1.2 mm thick, Heavy Duty Follower Spring, Chain Style Follower Handle, large rolled threads for fast & easy re-loading

Precision CNC machined Die cast Aluminium Grease Gun Head with threaded port for use with Jiabara Style Grease Cartridges popular in Japan.

Capacity

400 gms grease cartridge or 600 cc bulk fill

Complete with 150 mm Steel Extension & professional Grease Coupler



Jiabara Grease Cartridge used with Lever Grease Gun - Japanese Style (not included)

Precision Machined Aluminium Die Cast Grease Gun Head

Non Slip Textured Powder coated finish (accepts Jiabara style grease cartridges threaded M15 x 2.5)

∅ 59.7 mm

Heavy Duty Chain for operating rubber follower

DELIVERS

Upto 0.90 gms / stroke



CAT. NR.	ORD. NR.	THREADS
G81R/B	42790	1/8" BSPT



10,000 PSI (690 BAR / 69 MPa)



CARTRIDGE LOADING



SUCTION FILL



HAND FILL

08

DOUBLE LEVER GREASE GUN

NEW!

G83



AUTOMOTIVE



INDUSTRIAL



WORKSHOP

Double lever grease gun for quick effortless High pressure greasing applications

Screw-in cartridge works on special "vacuum technology" that ensures full utilization of grease in the cartridge, as well as eliminates priming issues associated with conventional grease guns

Seal guards at the two ends of the cartridge create vacuum that pulls out grease thus emptying the cartridge completely

Robust high tolerance aluminum die cast head

Minimal wearing parts give it a long life

Protective cap for hose storage when not in use, prevents contamination at the hose end

No connections hence no potential leaks or occurrence of contamination

Delivers

Upto 0.80 gm / stroke
(1 oz. per 35 strokes)

Complete with 12" (300 mm) high pressure flexible hose with 4 jaw coupler

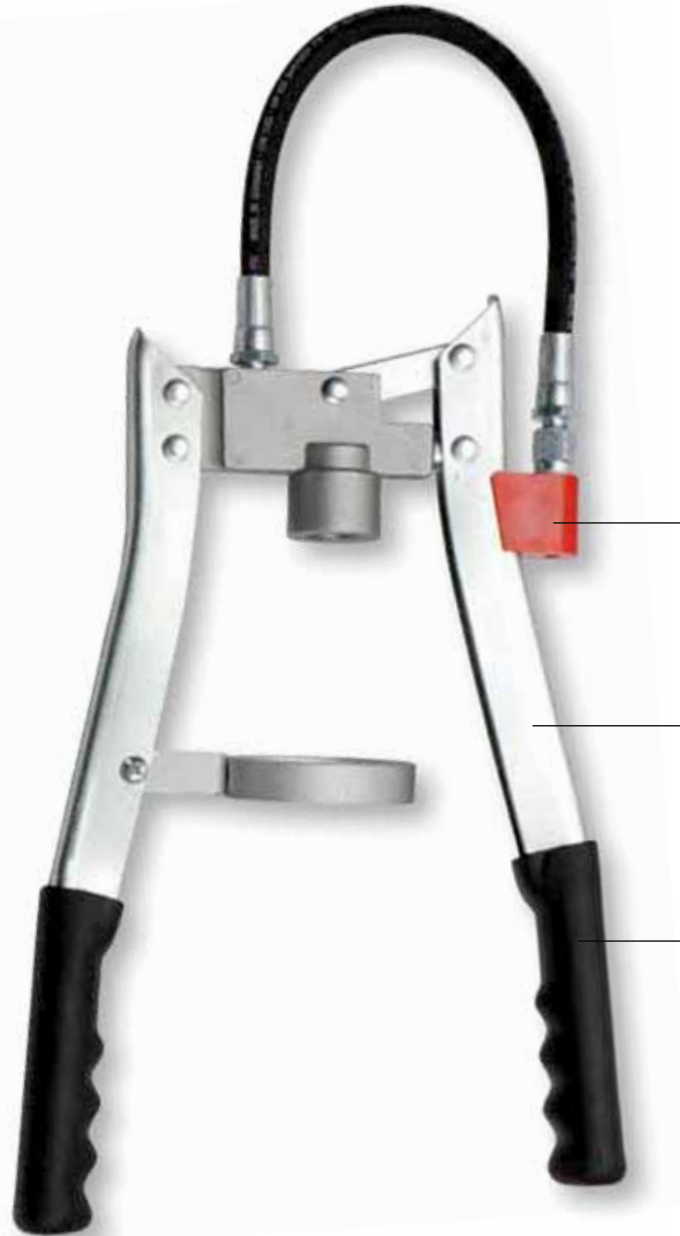

Protective cap to prevent contamination at the hose end

Rugged & robust zinc plated lever handle

Ergonomic rubber grip for convenience in use

DELIVERS

Upto 0.8 gm / stroke
Upto 1 oz. / 35 strokes



**7,500 PSI
(517 BAR)**



**CARTRIDGE
LOADING**

CAT. NR.	ORD. NR.	THREADS
G83F-HP/B	42795	1/8"BSPT
G83F-HP/M	42796	M10 X 1

09

PISTOL GRIP GREASE GUN - PROFESSIONAL

G32



AUTOMOTIVE



INDUSTRIAL

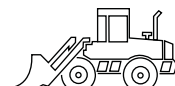

CONSTRUCTION



AGRICULTURE

Lifetime product, ideal for frequent greasing applications

Patented feather touch design for minimal effort

Most useful for greasing in confined spaces or where access to grease fitting is restricted

Incorporates a unique variable stroke feature, not common with Pistol Grease guns. This allows the gun to reach increased greasing pressures from short strokes & high greasing volumes from full strokes

Machined to very close tolerances with perfect fits

Built Tough

Robust barrel 0.049" (1.2 mm) thick, Heavy Duty Follower Spring, CNC machined grease gun head, large rolled threads for fast & easy re-loading

Capacity

14 oz. (400 gms) grease cartridge or 500 cc bulk fill

Delivers

1.1/2 times more grease per stroke & at the same time generating pressures upto 7,500 PSI (517 BAR)

Complete with 9" (225 mm) high pressure flexible hose & professional 4 jaw coupler with ball check

Head incorporates a unique bulk loader, which doubles as an air bleeder

Designed for highest convenience in use with one hand operation & minimum effort that any gun can offer

One piece aluminum die cast head & fixed handle offers extra strength & convenience in use

Non slip textured finish

2-1/4" (57.15 mm)

Unique Lock Lever mechanism allows user to easily lock plunger rod in any position

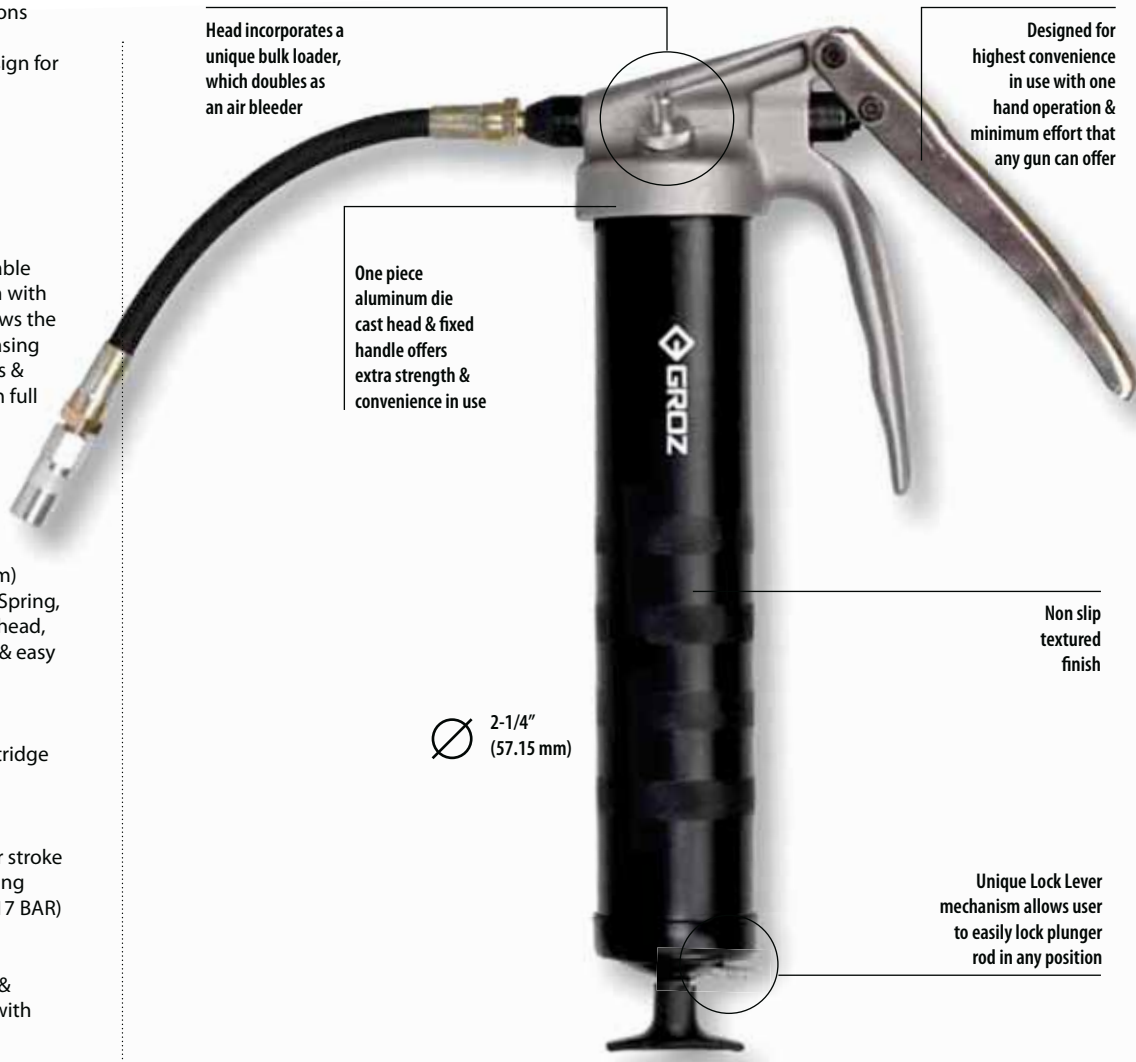

DELIVERS

Upto 0.68 gm / stroke
Upto 1 oz. / 40 strokes



7,500 PSI (517 BAR)



VARIABLE STROKE



NO FALSE LUBRICATION



CARTRIDGE LOADING



SUCTION FILL



FILLER PUMP LOADING

Grease Gun can be custom manufactured with zinc head for use in underground mines

CAT. NR.	ORD. NR.	THREADS
* G32F-HP9/B	43061	1/8" BSPT
G32F-HP9/M	43062	M10 x 1
* G32F-HP9/N	43063	1/8" NPT

Key * Best Seller

10

'VARIO' PREMIUM PISTOL GRIP GREASE GUNS

G55

G65



AUTOMOTIVE



INDUSTRIAL

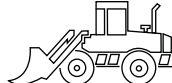

CONSTRUCTION



AGRICULTURE

Ergonomic One hand Operation Grease Gun

Unique Adjustable Stroke Mechanism

for both High Volume & High Pressure applications. High volume for faster greasing & High pressure for use in cold weather

Change in stroke achieved through simple press of the movable handle

Solid 0.43" (11 mm) dia. Piston for more grease discharge per stroke

Drop Resistant Pistol Assembly

Robust Aluminum Die cast Grease Gun Head with bulk filler

Rolled cylinder threads offer maximum strength

Handles NLGI 1, 2 & 3 grease

Complete with 12" (300 mm) high pressure flexible hose & professional 4 jaw coupler with ball check

UNIQUE ADJUSTABLE MECHANISM
HIGH PRESSURE / HIGH VOLUME
High Pressure for use in cold weather
High volume for faster greasing

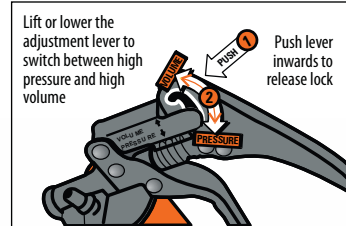

Automatic Air Release Valve

G55

For use with 14 oz. (400 gms) grease cartridge or 500 cc bulk grease

2-1/4" (57.15 mm)

G65

For use with 450 gms grease cartridge, popular in Australia & New Zealand

2-1/4" (57.15 mm)

DELIVERS

Upto 0.84 gms / stroke
Upto 1 oz. / 36 strokes



7,000 PSI (480 BAR)



CARTRIDGE LOADING



SUCTION FILL



FILLER PUMP LOADING

CAT. NR.	ORD. NR.	CARTRIDGE CAPACITY	BULK CAPACITY	THREADS
G55F-HP/B	43095	14 oz. (400 gms)	500 cm ³	1/8" BSPT
G55F-HP/M	43096	14 oz. (400 gms)	500 cm ³	M10 x 1
◆ G55F-HP/N	43098	14 oz. (400 gms)	500 cm ³	M10 x 1
G65F-HP/B	43088	450 gms	650 cm ³	1/8" BSPT

Key ◆ New

11

DUAL DISCHARGE PISTOL GRIP GREASE GUN

NEW!

G31



AUTOMOTIVE



AGRICULTURE



INDUSTRIAL

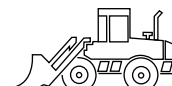

CONSTRUCTION

One Hand Operation with a choice of front & top discharge ports

Dual Ports

Make greasing easier especially on grease fittings with limited access

Heavy duty aluminium die cast head with super strong pistol handle

Plated finish on the Grease Gun barrel makes it easy to find / locate guns left in the farm or under a tractor

Pistol handle designed to prevent fingers from "pinching"

Develops

Upto 5,000 PSI / 345 BAR

2 Way Loading

14 oz. cartridge or Suction Fill

Complete with 12" (300 mm) flexible hose, 4" (100 mm) steel extension & professional 4 jaw grease coupler



Front Port



Top Port

DELIVERS

Upto 0.50 gms / stroke
Upto 0.70 oz. / 40 strokes

CAT. NR.	ORD. NR.	CARTRIDGE CAPACITY	BULK CAPACITY	THREADS
G31RF/B	43015	14 oz. (400 gms)	500 cm ³	1/8" BSPT
G31RF/M	43016	14 oz. (400 gms)	500 cm ³	M10 x 1
G31RF/N	43017	14 oz. (400 gms)	500 cm ³	1/8" BSPT



5,000 PSI (345 BAR)



CARTRIDGE LOADING



SUCTION FILL

12

'ULTIMATE' ALL WEATHER PISTOL GRIP GREASE GUNS



AUTOMOTIVE



INDUSTRIAL

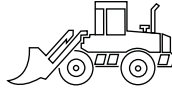

CONSTRUCTION



AGRICULTURE

All weather grease gun, designed especially for ease of use in very cold weather conditions

Venturi Mechanism coupled with a large grease inlet helps retain prime

Built tough

Robust grease gun barrel 0.049" (1.2 mm) thick, heavy duty follower spring, CNC machined grease gun head machined to very close tolerances that ensures perfect fits, large rolled threads for fast & easy re-loading

Double lipped rubber follower for use with 14 oz. (400 gms) grease cartridge / bulk, without any changeover

Heavy Duty plunger spring design keeps grease compressed, free of air pockets

Drop resistant Pistol Grip design

Also available with **Unique Adjustable Stroke Mechanism** that switches between high volume & high pressure applications with ease

High volume for faster greasing and high pressure for use in cold weather

Works with all grease types NLGI 1, 2 & 3

Develops

Upto 7,000 PSI / 483 BAR

Head incorporates a unique bulk loader, which doubles as an Air Bleeder

Compression Spring

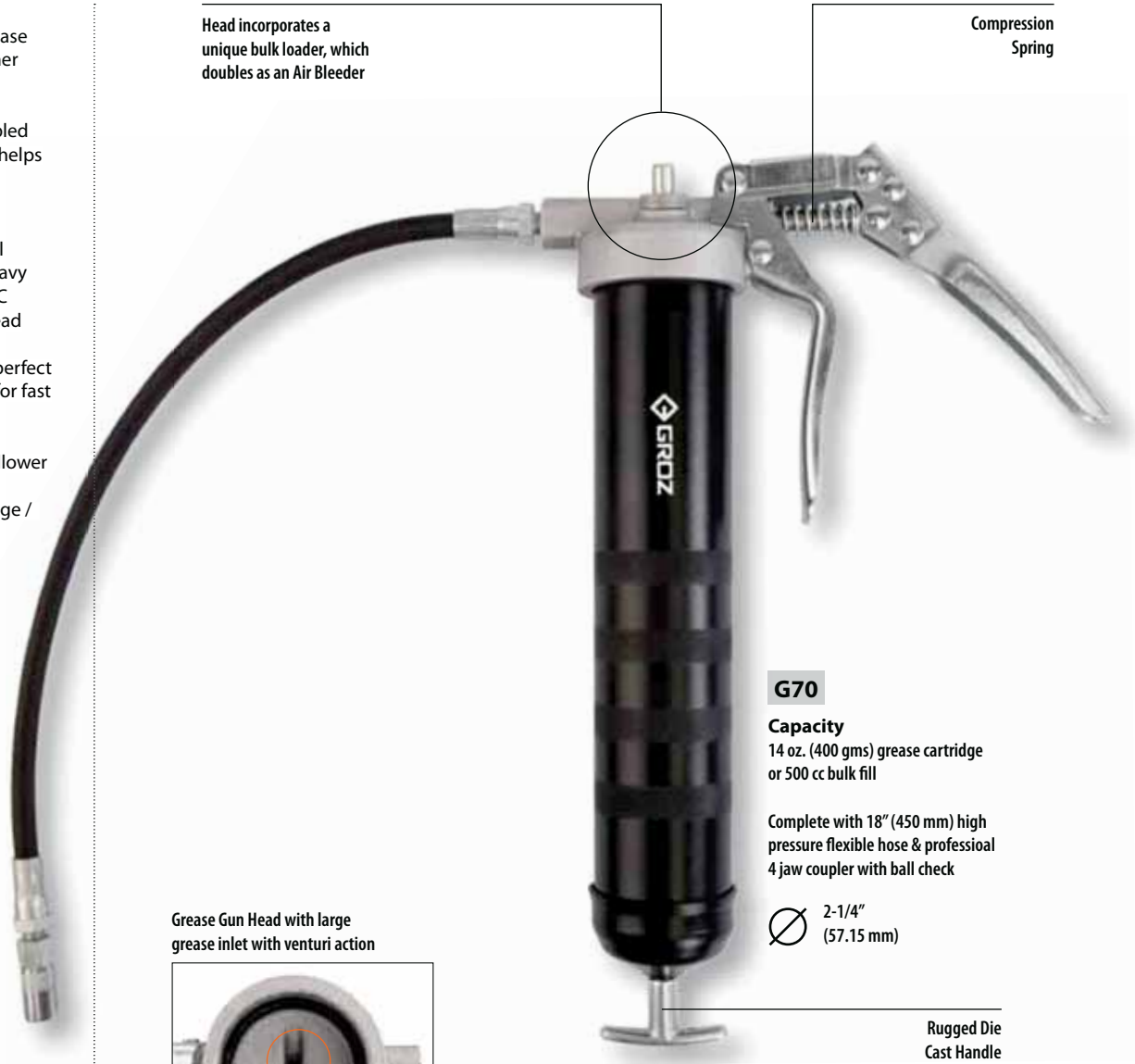

G70

Capacity

14 oz. (400 gms) grease cartridge or 500 cc bulk fill

Complete with 18" (450 mm) high pressure flexible hose & professional 4 jaw coupler with ball check

2-1/4" (57.15 mm)

Rugged Die Cast Handle

Grease Gun Head with large grease inlet with venturi action



Premium Double Lipped Grease Follower for use with 14 oz. (400 gms) grease cartridge



DELIVERS

FOR G70
Upto 0.68 gm / stroke
Upto 1 oz. / 40 strokes

FOR G80 & G85
Upto 0.90 gm / stroke
Upto 1.30 oz. / 40 strokes



NEW!
NEW!

- G70**
- G80**
- G85**

**UNIQUE ADJUSTABLE MECHANISM
HIGH PRESSURE / HIGH VOLUME**

High Pressure for use in cold weather
High volume for faster greasing

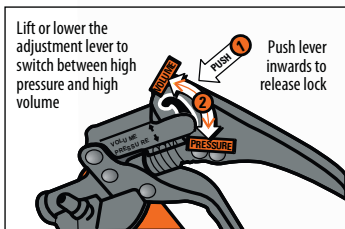

Head incorporates a unique bulk loader which doubles as an air bleeder

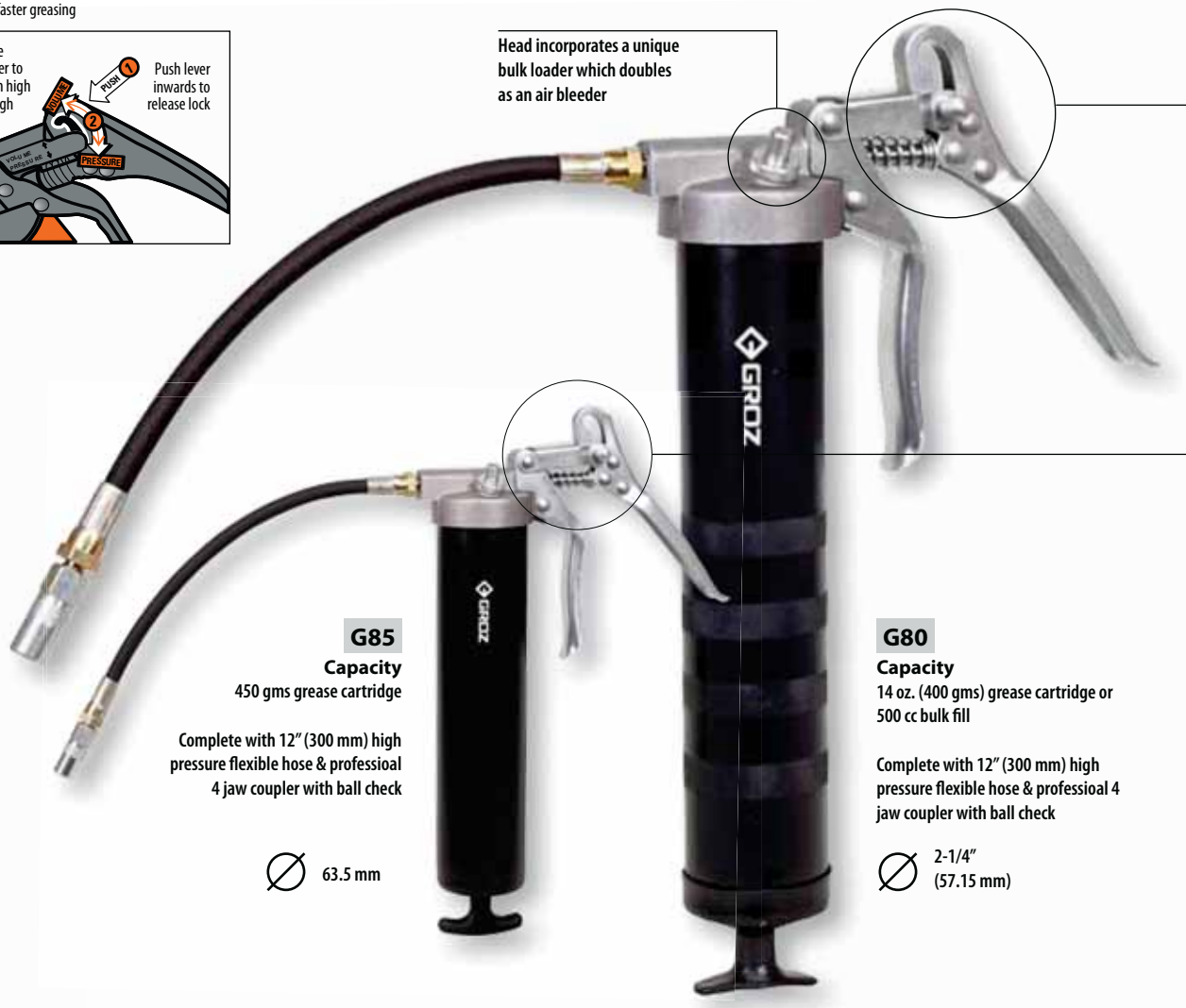

G85

Capacity

450 gms grease cartridge

Complete with 12" (300 mm) high pressure flexible hose & professional 4 jaw coupler with ball check

63.5 mm

G80

Capacity

14 oz. (400 gms) grease cartridge or 500 cc bulk fill

Complete with 12" (300 mm) high pressure flexible hose & professional 4 jaw coupler with ball check

2-1/4" (57.15 mm)

CAT. NR.	ORD. NR.	CARTRIDGE CAPACITY	BULK CAPACITY	THREADS
G70F-HP18/B	43040	14 oz. (400gms)	500 cm ³	1/8" BSPT
G70F-HP18/M	43041	14 oz. (400gms)	500 cm ³	M10 x 1
* G70F-HP18/N	43042	14 oz. (400gms)	500 cm ³	1/8" NPT

CAT. NR.	ORD. NR.	CARTRIDGE CAPACITY	BULK CAPACITY	THREADS
G80F-HP/B	43045	14 oz. (400gms)	500 cm ³	1/8" BSPT
G80F-HP/M	43046	14 oz. (400gms)	500 cm ³	M10 X 1
◆ G80F-HP/N	43047	14 oz. (400gms)	500 cm ³	1/8" NPT
G85F-HP/B	43048	450 gms	650 cm ³	1/8" BSPT

Key * Best Seller ◆ New



**7,000 PSI
(483 BAR)**



**CARTRIDGE
LOADING**



**SUCTION
FILL**



**FILLER PUMP
LOADING**

13

PISTOL GRIP GREASE GUNS



AUTOMOTIVE



INDUSTRIAL

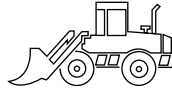

CONSTRUCTION

G5

G5-PRO

G4-PST

Most popular One Hand Operated Grease Gun designed for use in confined spaces or where access to grease nipple is restricted

Built Tough

Robust barrel 0.049" (1.2 mm) thick, Heavy Duty Follower Spring, CNC machined grease gun head, large rolled threads for fast & easy re-loading

Heavy Duty Aluminum Die Cast Head & super strong pistol grip handle

Pistol Handle designed to prevent fingers from "Pinching"

Develops

5,000 PSI / 345 BAR

Complete with a choice of 4" (100 mm) steel extension or 12" (300 mm) flexible hose & professional 4 jaw coupler with ball check



Grease Gun can be custom manufactured with zinc head for use in underground mines

DELIVERS

Upto 0.50 gm / stroke
Upto 0.70 OZ. / 40 strokes



G4-PST

For use with 450 gms grease cartridge, popular in Australia & New Zealand. Head fitted with steel block nut

63.5 mm



G5-PRO

For use with 14 oz. (400 gms) grease cartridge or 500 cc bulk. Head fitted with bulk loader & air release valve. Comfortable vinyl grip on movable handle

2-1/4" (57.15 mm)

G5

For use with 14 oz. (400 gms) grease cartridge or 500 cc bulk

2-1/4" (57.15 mm)

CAT. NR.	ORD. NR.	CAT. NR.	ORD. NR.	CARTRIDGE CAPACITY	BULK CAPACITY	THREADS
WITH STEEL EXTENSION & COUPLER		WITH FLEXIBLE HOSE & COUPLER				
G5R/B	43000	G5F/B	43020	14 oz (400 gms)	500cm ³	1/8" BSPT
G5R/M	43001	G5F/M	43021	14 oz (400 gms)	500cm ³	M10 x 1
* G5R/N	43002	* G5F/N	43022	14 oz (400 gms)	500cm ³	1/8" NPT
* G4R/PST/B	43080	* G4F/PST/B	43085	450 gms	650cm ³	1/8" BSPT
G5R/PRO/B	43050	G5F/PRO/B	43070	14 oz (400 gms)	500cm ³	1/8" BSPT
G5R/PRO/M	43051	G5F/PRO/M	43071	14 oz (400 gms)	500cm ³	M10 x 1
G5R/PRO/N	43052	G5F/PRO/N	43072	14 oz (400 gms)	500cm ³	1/8" NPT

Key * Best Seller



5,000 PSI (345 BAR)



CARTRIDGE LOADING



SUCTION FILL



FILLER PUMP LOADING (ONLY G5-PRO)

14

series **PISTOL GRIP GREASE GUN - 'V' SERIES**

V5

DIY

Value Priced One Hand Operated Pistol Grip Grease Gun

Aluminium Die Cast head fitted with air release valve

Hi-visibility orange powder coated finish

Develops
5,000 PSI / 345 BAR

Capacity
14 oz. (400 gms) grease cartridge or 500 cc bulk

Complete with a choice of 4" (100 mm) steel extension or 12" (300 mm) flexible hose & standard 4 jaw coupler with ball check



DELIVERS

Upto 0.50 gm / stroke
Upto 0.70 oz. / 40 strokes



5,000 PSI
(345 BAR)



CARTRIDGE
LOADING



SUCTION
FILL

CAT. NR.	ORD. NR.	CAT. NR.	ORD. NR.	CARTRIDGE CAPACITY	BULK CAPACITY	THREADS
WITH STEEL EXTENSION & COUPLER		WITH FLEXIBLE HOSE & COUPLER				
V5R/B	42950	V5F/B	42970	14 oz (400 gms)	500cm ³	1/8" BSPT
V5R/M	42951	V5F/M	42971	14 oz (400 gms)	500cm ³	M10 x 1
V5R/N	42952	V5F/N	42972	14 oz (400 gms)	500cm ³	1/8" NPT

15

QUICK CONNECT PISTOL GRIP GREASE GUN

NEW!

G80Q



AUTOMOTIVE



INDUSTRIAL

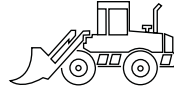

CONSTRUCTION



AGRICULTURE



Quick-Load Technology is a unique concept that allows for fast reloading process. Quick-Load features threadless quick connect barrel that significantly reduces downtime. Simply pull the Quick-Load switch to disengage the barrel. Never worry about crossing threads on your barrel again!

This grease gun rivals others in quality, function and pressure output while maintaining the convenience of one hand operation

Grease gun head fitted with bulk loader & automatic release valve. Automatic release valve bleeds out air when loading grease guns, without the need to manually operate the valve

Unique Adjustable Stroke Mechanism that switches between high volume & high pressure applications with ease

Grease inlet with venturi action helps retain prime

Double lipped rubber follower allows use with grease cartridge bulk without any change-over

Capacity
14 oz. (400 gms) grease cartridge or 500 cc bulk fill

Works with NLGI 1, 2 & 3 greases

Complete with 18" (450 mm) high pressure flexible hose & professional 4 jaw coupler.

DELIVERS

Upto 0.90 gm / stroke
Upto 1 oz. / 31 strokes

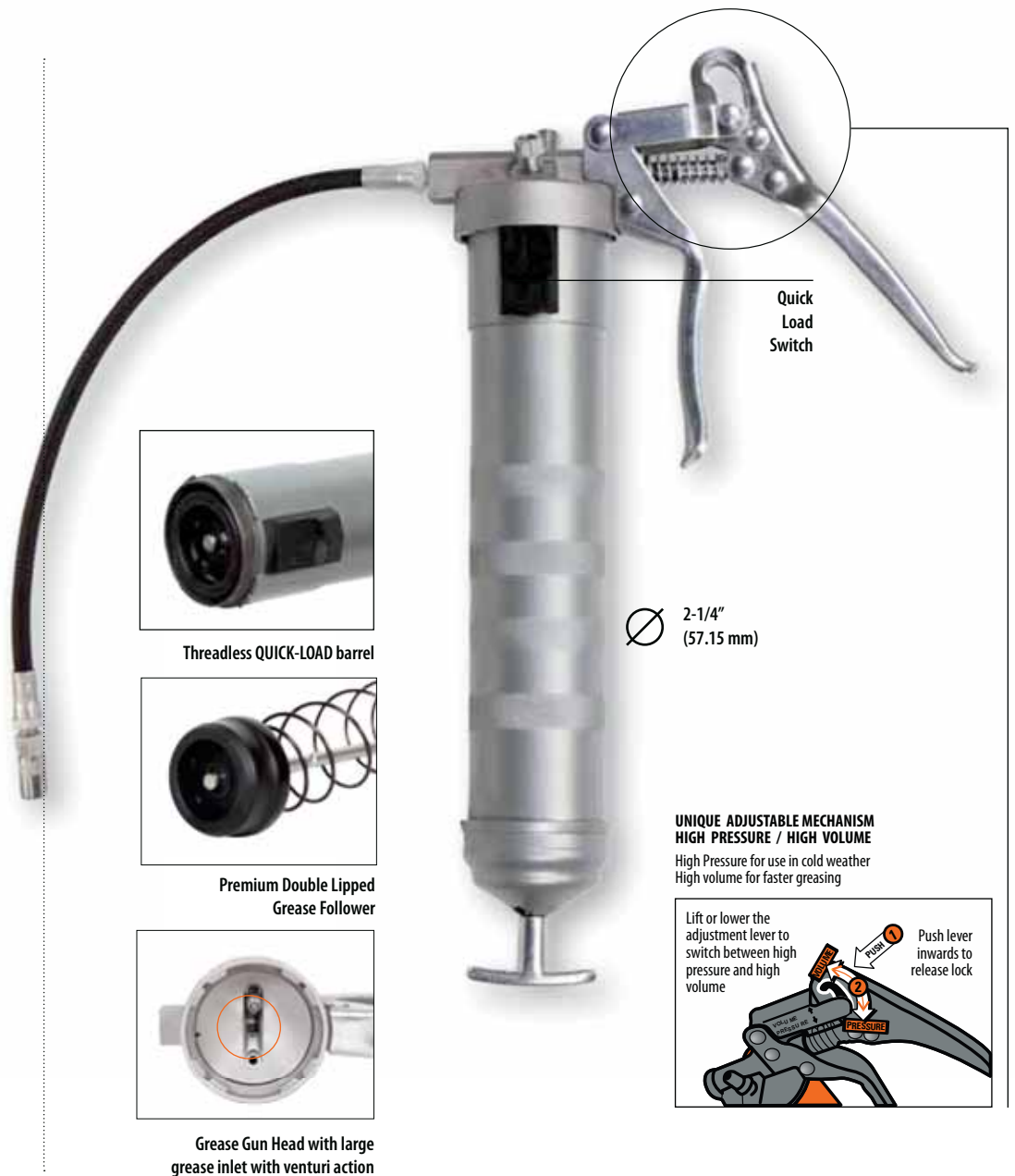

CAT. NR.	ORD. NR.	THREADS
G80Q/F-HP18/B	43043	1/8" BSPT
G80Q/F-HP18/M	43044	M10 X 1
G80Q/F-HP18/N	43049	1/8" NPT



7,000 PSI
(483 BAR)



CARTRIDGE
LOADING



SUCTION
FILL



FILLER PUMP
LOADING

clear tube

A perfect addition to any lubrication program!!

- Proper identification of grease
- Eliminates cross-contamination
- Visibility of air pockets
- Visibility to remaining grease
- Eliminates risk of mixing greases

Clear tube equipment from Groz makes you 100% sure of what you are dispensing; ensuring you don't make costly mistakes that cannot be reversed.

Different equipment, machines, bearings and vehicles require different types of lubricants. Proper identification of the lubricant once installed in the equipment can be challenging.

An estimated 60% of bearing failures all over the world are due to lubricant cross contamination. This leads to costly downtime & expensive machinery repairs.

Switch to **'Clear Tube Equipment'** for you have a simple & cost effective means to prevent this

These have applications everywhere, especially in Marine, Naval Aviation, Military, & Food Industry



Also available with colour coded end caps for colour coding based on grease type, frequency of use or application point



**DROP RESISTANT
IMPACT RESISTANT
CRUSH PROOF**

Clear Tube Lever Grease Guns	pg 24
Clear Tube Pistol Grip Grease Guns	pg 25
Clear Tube Lever Oil Pump	pg 78
Clear Tube Suction Gun	pg110

16

CLEAR TUBE LEVER GREASE GUNS

NEW!

G1HD-CL

NEW!

G4HD-CL



INDUSTRIAL



DEFENCE

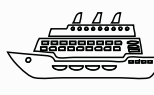

MARINE



FOOD

Unique concept & design that allows quick & clear lubricant identification, thus eliminating the risk of cross contamination or mixing of incompatible lubricants

Tough, impact resistant & drop resistant polycarbonate tube with Aluminium die cast adaptors

High tolerance Aluminium die cast head with bulk loader & air release valve

Variable stroke for ease of use in confined spaces

Develops 10,000 PSI / 690 BAR

Available in a choice of 14oz. (400 gm) capacity or 450 gm capacity popular in Australia & New Zealand

Complete with 6" (150 mm) steel extension & professional 4 jaw coupler with ball check



G1R/HD/B-CL

For use with 14 oz. (400 gms) grease cartridge or 500 cc bulk

BRL/G1-CL

Barrel only

Quick lubricant identification eliminating the risk of mixing incompatible or unspecified lubricants

! WARNING

Designed for use with grease only:
Do not use with: ESTER based Greases, Synthetic Greases such as Aeroshell 33 Grease, Aeroshell 7 Grease, Skydrol Products etc. These have an adverse effect on the clear polycarbonate tube & can cause fogging, cracking & fracturing of the tube.

DELIVERS

Upto 1 gm / stroke
Upto 1 oz. / 28 strokes

CAT. NR.	ORD. NR.	CARTRIDGE CAPACITY	BULK CAPACITY	THREADS
GREASE GUN				
G1R/HD/B-CL	46900	14 oz. (400 gms.)	500 cm ³	1/8" BSPT
G1R/HD/M-CL	46901	14 oz. (400 gms.)	500 cm ³	M10 X 1
G1R/HD/N-CL	46902	14 oz. (400 gms.)	500 cm ³	1/8" NPT
G4R/HD/B-CL	46903	450 gms	650 cm ³	1/8" BSPT
BARREL ONLY				
BRL/G1-CL	46990	14 oz. (400 gms.) replacement for clear tube barrel only		2.2806" x 16 UNF
BRL/G4-CL	46991	450 gms replacement for clear tube barrel only		2.5" x 16 UNF



10,000 PSI
(690 BAR)



CARTRIDGE
LOADING



FILLER PUMP
LOADING



VARIABLE
STROKE



SUCTION
FILL

17

CLEAR TUBE PISTOL GRIP GREASE GUN

NEW!

G5-CL

NEW!

G4-PST-CL



INDUSTRIAL



DEFENCE

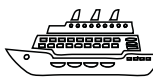

MARINE



FOOD

Unique concept & design that allows quick & clear lubricant identification, thus eliminating the risk of mixing of cross contamination or incompatible lubricants

Tough, impact resistant & drop resistant polycarbonate tube with Aluminium die cast adaptors

Heavy Duty Aluminum die cast head fitted with steel block nut

Develops
5,000 PSI / 345 BAR

Super strong pistol grip handle designed to prevent pinching of fingers

Available in choice of 14 oz. (400gm) capacity or 450 gm capacity popular in Australia & New Zealand

Complete with 4" (100 mm) steel extension, 12" (300 mm) flexible hose extension & professional 4 jaw coupler with ball check

DELIVERS

Upto 0.50 gm / stroke
Upto 0.70 oz. / 40 strokes



BRL/G1-CL

Barrel only



Quick lubricant identification eliminating the risk of mixing incompatible or unspecified lubricants



G4RF/PST/B-CL

For use with 450 gm grease cartridge or 650 cc bulk

CAT. NR.	ORD. NR.	CARTRIDGE CAPACITY	BULK CAPACITY	THREADS
GREASE GUN				
G5RF/B-CL	46920	14 oz. (400 gms.)	500 cm ³	1/8" BSPT
G5RF/M-CL	46921	14 oz. (400 gms.)	500 cm ³	M10 X 1
G5RF/N-CL	46922	14 oz. (400 gms.)	500 cm ³	1/8" NPT
G4RF/PST/B-CL	46923	450 gms	650 cm ³	1/8" BSPT
BARREL ONLY				
BRL/G1-CL	46990	Replacement clear tube barrel only 14 oz. (400 gms)		2.2806" X 16 UNF
BRL/G4-CL	46991	Replacement clear tube barrel only 450 gms		2.5" X 16 UNF

! WARNING

Designed for use with grease only:
Do not use with: ESTER based Greases, Synthetic Greases such as Aeroshell 33 Grease, Aeroshell 7 Grease, Skydrol Products etc. These have an adverse effect on the clear polycarbonate tube & can cause fogging, cracking & fracturing of the tube.



5,000 PSI (345 BAR)



CARTRIDGE LOADING



SUCTION FILL

18

MINI LEVER GREASE GUN

NEW!

G14



AUTOMOTIVE



AGRICULTURE

DIY

Mini Lever Grease Gun with die cast grease gun head

Compact Tool Box Size

Develops upto 6,000 PSI / 413 BAR, the highest in its class of any mini grease gun

Capacity

3 oz (85 gms) grease cartridge or 120 cc bulk fill

Complete with 6" steel extension and 4 jaw coupler with ball check

DELIVERS

Upto 0.55 gm / stroke
Upto 0.80 oz. / 40 strokes



6,000 PSI
(413 BAR)



CARTRIDGE
LOADING

When you need a tough little grease gun for hard to get in places, that doesn't take up a lot of space, THIS IS IT!

9-1/4"
(235 mm)

1.42"
(36 mm)

CAT. NR.	ORD. NR.	THREADS
G-14R/B	43280	1/8" BSPT
G-14R/M	43281	M10 X 1
G-14R/N	43282	1/8" NPT

19

PUSH TYPE GREASE GUNS

G6

G7



INDUSTRIAL

DIY

Push type grease gun for use with bulk grease only

Compact toolbox size, ideal for greasing impact wrenches, lawn mowers, chain saws, trailers, ATV's, autos & trucks etc

Develops

1,000 PSI / 69 BAR

Comes complete with Universal connector

Can be custom built with Pointed nozzle for special applications

DELIVERS

Upto 0.90 gm / shot
Upto 1 oz. / 32 shots



1,000 PSI
(69 BAR)



HAND
FILL



Align Push Gun straight with fitting



Push with palm of hand

CAT. NR.	ORD. NR.	BULK CAPACITY
* G6P	43100	30 cm ³
G7P	43101	125 cm ³

Key * Best Seller



G7
Capacity
125 cc
capacity

20

MINI PISTOL GREASE GUNS - DELUXE

G16



One hand Pistol grip grease gun with convenient pull type operating mechanism

Capacity

3 oz. (85 gms) grease cartridge

Available in a choice of black powder coated finish or textured zinc plated

Develops

3,500 PSI / 240 BAR

Complete with 4" steel extension and 4 jaw coupler with ball check



Front Discharge Port used for regular greasing applications

Top Port used primarily with flexible hose for greasing in inaccessible areas

1.42" (36 mm)

CAT. NR.	ORD. NR.	CAT. NR.	ORD. NR.	THREADS
POWDER COATED FINISH		ZINC PLATED FINISH		
* G-16/B	43250	G-16/ZN/B	43260	1/8" BSPT
G-16/M	43251	G-16/ZN/M	43261	M10 x 1
G-16/N	43252	* G-16/ZN/N	43262	1/8"NPT



3,500 PSI (240 BAR)



CARTRIDGE LOADING



DELIVERS

Upto 0.40 gm / stroke
Upto 0.60 oz. / 40 strokes

Key * Best Seller

21

MINI PISTOL GREASE GUN - POPULAR

G15



A low cost, compact tool box size grease gun, perfect for hard to reach jobs

One hand pistol grip grease gun with push type operating mechanism

Aluminum die cast head

Capacity

3 oz (85 gms) grease cartridge

Textured powdered coated finish for non-slip grip

Complete with 4" (100 mm) steel extension and 4 jaw coupler with ball check

CAT. NR.	ORD. NR.	THREADS
G-15/B	43200	1/8" BSPT
G-15/M	43201	M10 x 1
* G-15/N	43202	1/8"NPT



3,000 PSI (207 BAR)



CARTRIDGE LOADING



DELIVERS

Upto 0.40 gm / stroke
Upto 0.60 oz. / 40 strokes

1.42" (36 mm)

Key * Best Seller



22

AIR OPERATED GREASE GUNS



AUTOMOTIVE



INDUSTRIAL



CONSTRUCTION



AGRICULTURE

Ideal for use in factory maintenance, agricultural applications, fleet service or for use on trucks connected to vehicle air brake compressors

Air Operating Range
40–120 PSI (3-8 BAR)

Pressure Ratio
40:1

Air Compressor Volume
1 cfm / 0.026 cubic metre and above

Air Inlet Threaded
1/4" (F)

Each gun supplied with a male quick coupler fitting

Available in 2 versions

INTERMITTENT
Grease discharge with every press of trigger

AUTOMATIC
Continuous grease discharge with the trigger pressed

Complete with 6" (150 mm) steel extension or 12" (300 mm) flexible hose & professional 4 jaw coupler



Head casting fitted with bulk loader valve

DELIVERS



Upto 0.90 gm / shot
(1.30 oz. / 40 strokes for PGG)

Upto 400 gm / min
(14 oz. / min for AGG)



4,800 PSI
(330 BAR)



WARNING

Always use lubrication unit with Air Supply



PGG-4

Intermittent Action with grease discharge per shot. For use with 450 gms grease cartridge, popular in Australia & New Zealand

Ø 63.5 mm



AGG-1

Automatic Action with continuous grease discharge. For use with 14 oz. (400 gms) grease cartridge or 500 cc bulk grease

Ø 2-1/4" (57.15 mm)



AGG-4

Automatic Action with continuous grease discharge. For use with 450 gms grease cartridge, popular in Australia & New Zealand

Ø 63.5 mm

PGG-1

PGG-4

AGG-1

AGG-4

Heavy Duty aluminum die cast head with internal bore precision honed for rapid action

Ergonomic pistol grip and acute angle design allows for ease of operation, especially in narrow spaces

AIR INLET threaded 1/4" (F). Each gun supplied with a male quick coupler fitting



CARTRIDGE LOADING



SUCTION FILL



FILLER PUMP LOADING

PGG-1

Intermittent Action with grease discharge per shot. For use with 14 oz. (400 gms) grease cartridge or 500 cc bulk

Ø 2-1/4" (57.15 mm)

CAT. NR.	ORD. NR.	CAT. NR.	ORD. NR.	CARTRIDGE CAPACITY	BULK CAPACITY	THREADS
WITH STEEL EXTENSION & COUPLER		WITH FLEXIBLE HOSE & COUPLER				
INTERMITTENT ACTION GUN						
PGG/1R/B	43300	PGG/1F/B	43320	14 oz (400 gms)	500cm ³	1/8" BSPT
PGG/1R/M	43301	PGG/1F/M	43321	14 oz (400 gms)	500cm ³	M10 x 1
* PGG/1R/N	43302	PGG/1F/N	43322	14 oz (400 gms)	500cm ³	1/8" NPT
PGG/4R/B	43380	PGG/4F/B	43385	450 gms	650cm ³	1/8" BSPT
AUTOMATIC ACTION GUN						
AGG/1R/B	43303	AGG/1F/B	43323	14 oz (400 gms)	500cm ³	1/8" BSPT
AGG/1R/M	43304	AGG/1F/M	43324	14 oz (400 gms)	500cm ³	M10 x 1
* AGG/1R/N	43305	AGG/1F/N	43325	14 oz (400 gms)	500cm ³	1/8" NPT
AGG/4R/B	43381	AGG/4F/B	43389	450 gms	650cm ³	1/8" BSPT

Key * Best Seller

HIGH POWER AIR OPERATED GREASE GUN

G64



AUTOMOTIVE



INDUSTRIAL

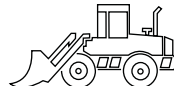

CONSTRUCTION

High power one shot air grease gun

Designed with grease cylinder on top for optimal balance

For use in factory maintenance, farm, fleet service or for use from vehicle air brake compressors

Air Operating Range
40–120 PSI (3–8 BAR)

Pressure Ratio
50:1

Air Compressor Volume
1 cfm / 0.026 cubic metre and above

For use with 14 oz (400 gms) grease cartridge or 500 cc bulk

Complete with 6" (150 mm) steel extension or 9" (225 mm) high pressure flexible hose & professional 4 jaw coupler

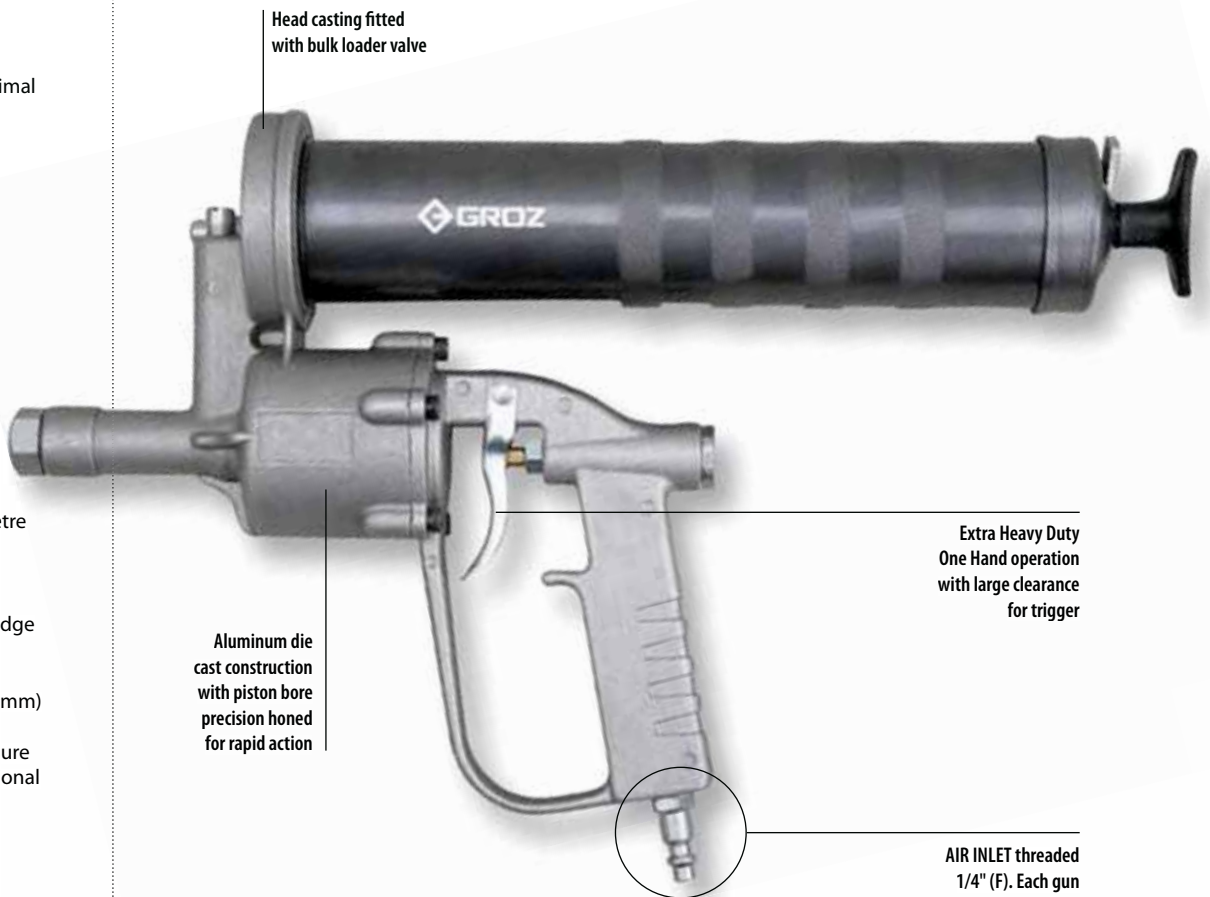

Head casting fitted with bulk loader valve

Aluminum die cast construction with piston bore precision honed for rapid action

Extra Heavy Duty One Hand operation with large clearance for trigger

AIR INLET threaded 1/4" (F). Each gun supplied with a male quick coupler fitting

DELIVERS

0.68 gm / shot
1 oz. / 40 shots

! WARNING

Always use lubricator unit with Air Supply



CARTRIDGE LOADING



SUCTION FILL



6,000 PSI (413 BAR)



FILLER PUMP LOADING

CAT. NR.	ORD. NR.	CAT. NR.	ORD. NR.	THREADS
WITH STEEL EXTENSION & COUPLER		WITH HIGH PRESSURE FLEXIBLE HOSE & COUPLER		
* G64R/B	43360	G64F-HP9/B	43370	1/8" BSPT
* G64R/M	43361	* G64F-HP9/M	43371	M10 x 1
G64R/N	43362	* G64F-HP9/N	43372	1/8"NPT

Key * Best Seller

24

19.2V BATTERY POWERED GREASE GUN

NEW!

BPGG-19



AUTOMOTIVE



INDUSTRIAL

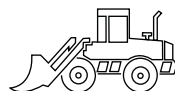

CONSTRUCTION



AGRICULTURE

Powerful 19.2V High Torque Motor

Standard 1.5Ah Ni-Cd Battery Pack

An additional 1.5Ah Ni-Cd Battery Pack for uninterrupted greasing

Automatic air release valve and bulk loader

Develops
6,000 PSI / 413 BAR

One Hour Quick Charger (each battery charge provides power to dispense upto 6 grease cartridges in free flow condition)

Complete with 30" (760 mm) high pressure hose with spring guard on both ends (prevents hose from kinking) & high pressure 4 jaw grease coupler

Designed for use by mechanics, technicians, maintenance staff, farmers etc for everyday greasing and preventive maintenance jobs

Available in a choice of 14 oz. (400 gm) or 450 gm capacity, popular in Australia & New Zealand



Comes with Blow Moulded Case for conveniently storing when not in use

Shoulder Strap included

Safety Valve releases grease at pressures over 6,000 PSI, preventing damage to gun due to excessive back pressure

Automatic Air Release Valve



6,000 PSI
(413 BAR)



CARTRIDGE LOADING



SUCTION FILL



FILLER PUMP LOADING

CAT. NR.	ORD. NR.	DESCRIPTION
GREASE GUN ASSEMBLY		
BPGG/19/US	47200	14 oz. (400 gm) Grease Gun, 110V/60 Hz. Battery Charger with US Plug
BPGG/19/EU	47201	14 oz. (400 gm) Grease Gun, 220V/50 Hz. Battery Charger with EU Plug
BPGG/19/UK	47202	14 oz. (400 gm) Grease Gun, 220V/50 Hz. Battery Charger with UK Plug
BPGG/19/AU	47203	450 gm Grease Gun, 220V/50 Hz. Battery Charger with AU Plug
SPARE PARTS & ACCESSORIES		
RB/BPGG/19N	47250	Rechargeable Battery, 19.2V, 1.5 Ah, Ni-Cd
BC/BPGG/19N/US	47251	1 hour cUL listed Battery Charger, 110V/60Hz, 19.2V, US Plug
BC/BPGG/19N/EU	47252	1 hour CE Energy Saving Battery Charger, 220V/50Hz, 19.2V, EU Plug
BC/BPGG/19N/UK	47253	1 hour CE Energy Saving Battery Charger, 220V/50Hz, 19.2V, UK Plug
BC/BPGG/19N/AU	47257	1 hour CE Energy Saving Battery Charger, 220V/50Hz, 19.2V, AU Plug
SS/BPGG/19N	47254	Carrying / Shoulder Strap
BMC/BPGG/19N	47255	Carrying Case / Blow Moulded Case
HOS/BG/30/N	47256	30" (760 mm) Replacement Hose

DELIVERS

Upto 85 gms / minute in free flow
Upto 3 oz. /minute in free flow



1.5Ah Ni-Cd
BATTERY PACKS

25

HYDRAULIC COUPLERS & SETS

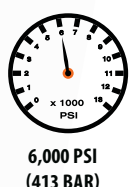

HC-10

STANDARD

Ideal for use with grease guns for general maintenance

Narrow coupler design for use on fittings with limited access

Milled slot for easy tightening

Fully hardened spring steel jaws



4 JAW CONSTRUCTION



WITHOUT BALL CHECK



FOR HAND OPERATED GREASE GUNS

CAT. NR.	ORD. NR.	THREADS
HC/10/4/B	43516	1/8" BSPT
HC/10/4/M	43517	M10 x 1
HC/10/4/N	43518	1/8" NPT

HC-11

STANDARD

Most popular for use with grease guns for general maintenance

Narrow coupler design for use on fittings with limited access

Milled slot for easy tightening

Fully hardened spring steel jaws



4 JAW CONSTRUCTION



WITH BALL CHECK



FOR HAND OPERATED GREASE GUNS

CAT. NR.	ORD. NR.	THREADS
HC/11/4/B	43510	1/8" BSPT
HC/11/4/M	43511	M10 x 1
* HC/11/4/N	43512	1/8" NPT

Key * Best Seller

HC-14

PROFESSIONAL

Best selling coupler for professional use

Hardened coupler body withstands high pressure without deformation

Fully hardened spring steel jaws

Hexagonal nut for easy tightening



4 JAW CONSTRUCTION



3 JAW CONSTRUCTION



WITH BALL CHECK



FOR HAND OPERATED GREASE GUNS

CAT. NR.	ORD. NR.	THREADS
4 JAW COUPLERS		
* HC/14/4/B	43500	1/8" BSPT
* HC/14/4/M	43501	M10 x 1
* HC/14/4/N	43502	1/8" NPT
3 JAW COUPLERS		
HC/14/3/B	43503	1/8" BSPT
HC/14/3/M	43504	M10 x 1
* HC/14/3/N	43505	1/8" NPT

Key * Best Seller

HC-10

HC-14

HC-11

HC-18

HC-19



HC-18

PROFESSIONAL

For professional use

Hardened coupler body withstands high pressure without deformation

Fully hardened spring steel jaws

Hexagonal nut for easy tightening



4 JAW CONSTRUCTION



3 JAW CONSTRUCTION



WITHOUT BALL CHECK



FOR HAND OPERATED GREASE GUNS

CAT. NR.	ORD. NR.	THREADS
4 JAW COUPLERS		
HC/18/4/B	43535	1/8" BSPT
HC/18/4/M	43536	M10 x 1
HC/18/4/N	43537	1/8" NPT
3 JAW COUPLERS		
HC/18/3/B	43507	1/8" BSPT
HC/18/3/M	43508	M10 x 1
HC/18/3/N	43509	1/8" NPT

HC-19



PROFESSIONAL - SLIM

For professional use

Amongst the Slimmest Jaw type Grease Coupler in the world! Ideal for use in confined spaces & fittings with narrow access

Hardened Coupler Body withstands high pressure without deformation

Fully hardened spring steel jaws

Coupler Nut & Body can be hand tightened for adjusting to variation in grease nipple sizes



3 JAW CONSTRUCTION



WITHOUT BALL CHECK



FOR HAND OPERATED GREASE GUNS

CAT. NR.	ORD. NR.	THREADS
HC/19/3/B	43590	1/8" BSPT
HC/19/3/M	43591	M10 X 1
HC/19/3/N	43592	1/8" NPT

HYDRAULIC COUPLER SETS - STANDARD

Most popular narrow design couplers with ball check available as a countertop display of 54 pcs

CAT. NR.	ORD. NR.	THREADS
4 JAW COUPLERS		
HC/11/4/B/ST54	43581	1/8" BSPT
HC/11/4/M/ST54	43582	M10 x 1
HC/11/4/N/ST54	43583	1/8" NPT

HYDRAULIC COUPLER SETS - PROFESSIONAL

Professional use 4 jaw couplers with hardened body, ball check and hexagonal nut that allows easy tightening, available as a countertop display of 54 pcs

CAT. NR.	ORD. NR.	THREADS
4 JAW COUPLERS		
HC/14/4/B/ST54	43584	1/8" BSPT
HC/14/4/M/ST54	43585	M10 x 1
HC/14/4/N/ST54	43586	1/8" NPT

Using Couplers

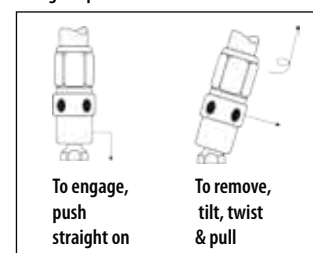

26

HYDRAULIC COUPLERS - HEAVY DUTY

HC-12

Recommended for use with air operated grease guns

Hardened coupler body with double wall thickness withstands high pressure without deformation

Fully hardened spring steel jaws

Hexagonal nut for easy tightening



**10,000 PSI
(690 BAR)**

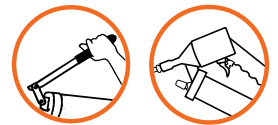

**FOR HAND AND AIR OPERATED
GREASE GUNS**



**3 JAW
CONSTRUCTION**



**4 JAW
CONSTRUCTION**



**WITH
BALL CHECK**

CAT. NR.	ORD. NR.	THREADS
4 JAW COUPLERS		
HC/12/4/B	43520	1/8" BSPT
HC/12/4/M	43521	M10 x 1
* HC/12/4/N	43522	1/8" NPT
3 JAW COUPLERS		
HC/12/3/B	43523	1/8" BSPT
HC/12/3/M	43524	M10 x 1
HC/12/3/N	43525	1/8" NPT

Key * Best Seller

27

HYDRAULIC COUPLER - AIR-O

HC-P

Recommended for use with grease control valves

Hardened coupler body & all internal parts withstand high dynamic pressures without deformation

Fully hardened reversible spring steel jaws for extended service life

Hexagonal nut for easy tightening

100% pressure tested



**7,500 PSI
(517 BAR)**

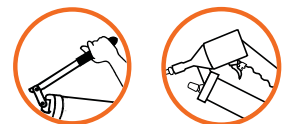

**FOR HAND AND AIR OPERATED
GREASE GUNS**



**3 JAW
CONSTRUCTION**



**WITH BALL
CHECK**

CAT. NR.	ORD. NR.	THREADS
3 JAW COUPLERS		
HC/P/3/B	43540	1/8" BSPT
HC/P/3/M	43541	M10 x 1
* HC/P/3/N	43542	1/8" NPT

Key * Best Seller

28

HYDRAULIC COUPLERS -
90°

HC-R

Designed for right angled discharge of grease.

Very useful for greasing fittings with limited access or in low heights where a grease gun with regular coupler is difficult to use, such as on Chrysler models

Fits all standard grease guns

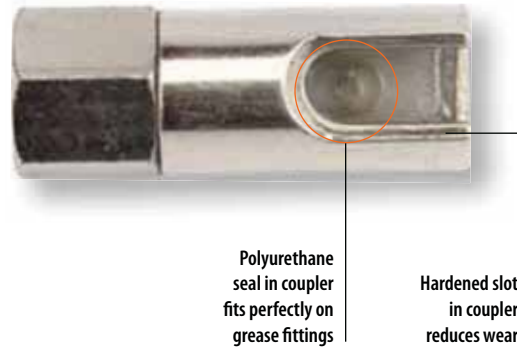

Polyurethane seal in coupler fits perfectly on grease fittings

Hardened slot in coupler reduces wear



WITHOUT BALL CHECK



FOR HAND OPERATED GREASE GUNS

CAT. NR.	ORD. NR.	THREADS
HC/R/01/B	43550	1/8" BSPT
HC/R/01/M	43551	M10 x 1
* HC/R/01/N	43552	1/8" NPT

Key * Best Seller



1,000 PSI
(69 BAR)

Right angled coupler used for greasing the axle of a low height truck where access to the grease fittings is only through a side



29

HYDRAULIC COUPLERS -
360°

HC-SW

An excellent coupler for effective lubrication of difficult & hard to reach grease fittings

Jaws are fully hardened for extended service life

Hardened coupler body & swivel joints withstand high-pressure applications without deformation

Zinc plated finish

Spring loaded ball check valve helps retain pressure

Swivels in full 360° circle & locks conveniently at any 45° position. 45° angle gives easy access to most grease fittings

Hexagonal nut allows easy tightening



0.67"
(17 mm)

CAT. NR.	ORD. NR.	THREADS
HC/SW/3/B	43560	1/8" BSPT
HC/SW/3/M	43561	M10 x 1
* HC/SW/3/N	43562	1/8" NPT

Key * Best Seller



7,000 PSI
(483 BAR)



3 JAW CONSTRUCTION



WITH BALL CHECK



FOR HAND OPERATED GREASE GUNS

30

BUTTON HEAD COUPLERS

BHC-10

PCN-1

HOC-1

PCN-2

PCN-3

A range of couplers for use with button head grease fittings, found mostly on heavy machinery, agricultural or contractor's equipment

Zinc die cast construction

Couplers conveniently slide over the face of the button head fitting

All couplers have a metal seal that imparts increased resistance to wear

NOTE
GROZ also manufactures a range of Button Head Grease Fittings. Refer to page 51 for details

BHC-10

Swivelling for 5/8" (16 mm) Button Head Fittings



3,000 PSI
(207 BAR)



PCN-1

Fixed Push-On for 5/8" (16 mm) Button Head Fittings



3,000 PSI
(207 BAR)



HOC-1

Fixed Hook-On for 5/8" (16 mm) Button Head Fitting



3,000 PSI
(207 BAR)



PCN-3

Medium Duty for 5/8" (16 mm) Button Head Fittings



6,000 PSI
(413 BAR)



PCN-2

Heavy Duty for 7/8" (22 mm) Giant Button Head Fittings



7,500 PSI
(517 BAR)



CAT. NR.	ORD. NR.	FOR BUTTON HEAD FITTING SIZE	THREADS
* BHC/10/B	43570	5/8" (16 mm)	1/8" BSPT
BHC/10/N	43572	5/8" (16 mm)	1/8" NPT
* HOC/1/B	43574	5/8" (16 mm)	1/8" BSPT
HOC/1/M	43575	5/8" (16 mm)	M10 x 1
HOC/1/N	43569	5/8" (16 mm)	1/8" NPT
PCN/1/B	43577	5/8" (16 mm)	1/8" BSPT
PCN/1/M	43563	5/8" (16 mm)	M10 x 1
PCN/1/N	43564	5/8" (16 mm)	1/8" NPT
PCN/3/B	43579	5/8" (16 mm)	1/8" BSPT
PCN/3/M	43565	5/8" (16 mm)	M10 x 1
PCN/3/N	43576	5/8" (16 mm)	1/8" NPT
PCN/2/B	43578	7/8" (22 mm)	1/8" BSPT
PCN/2/M	43566	7/8" (22 mm)	M10 x 1
PCN/2/N	43567	7/8" (22 mm)	1/8" NPT

Key * Best Seller



31

HYDRAULIC COUPLERS -
PIN TYPE

HC-13

Provides quick, positive and leakproof connection with pin type fittings

Hexagonal nut allows easy tightening

NOTE

GROZ also manufactures a range of Pin Type Grease Fittings. Refer to page 51 for details

CAT. NR.	ORD. NR.	THREADS
* HC/13/B	43530	1/8" BSPT
♦ HC/13/M	43532	M10 X 1
HC/13/N	43531	1/8" NPT

Key * Best Seller ♦ New



3,000 PSI
(207 BAR)



WITHOUT BALL
CHECK



FOR HAND OPERATED
GREASE GUNS

32

NEEDLE NOSE
DISPENSERS

DNN

Used for dispensing a fine line of grease

Needle design allows operator to contact flush on hard to reach hydraulic type fittings in inaccessible areas

Can be attached directly to steel extensions or flexible hoses

Special model available with shroud



DNN/1-8



DNN/1-8/S



DNN/1-1-2



DNN/6



Needle Nose Dispenser
used to Grease a fitting
with limited access

CAT. NR.	ORD. NR.	1/8" BSPT		1/8" NPT		NEEDLE LENGTH		NEEDLE DIAMETER		TIP DIAMETER	
						inch	mm	inch	mm	inch	mm
NEEDLE NOSE DISPENSERS											
DNN/1-8/B	44850	* DNN/1-8/N	44860	19/32"	15	0.187"	4.76	0.046"	1.17		
DNN/1-8/S/B (with shroud)	44853	-	-	19/32"	15	0.187"	4.76	0.046"	1.17		
S/DNN/1-8/B	44854	Replacement shroud only									
NARROW NEEDLE NOSE DISPENSERS											
DNN/1-1-2/B	44851	* DNN/1-1-2/N	44861	1.1/2"	38	0.156"	3.96	0.059	1.17		
DNN/6/B	44852	DNN/6/N	44862	6"	150	0.156"	3.96	0.059	1.17		

Key * Best Seller



6,000 PSI
(413 BAR)



FOR HAND OPERATED
GREASE GUN

33

GREASE INJECTOR NEEDLES

GIN

Lubricates in very tight spaces such as universal joints and sealed bearings

Equipped with grease fitting for quick connect operation

Complete with protective plastic holder

Available in standard or safety version with Aluminum Holder for safe & easy handling

GIN/01

Stainless Steel
1.1/2" (38 mm)
long needle

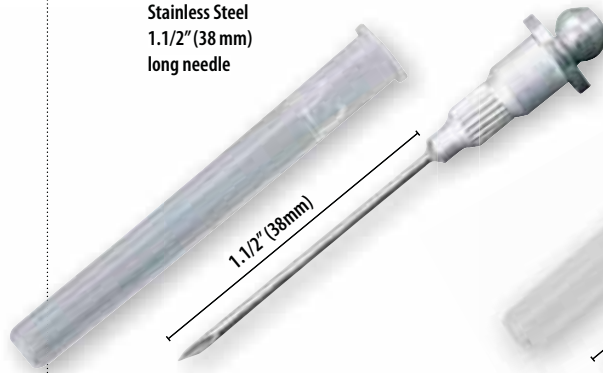

GIN/03

Aluminum Holder
with Stainless Steel
36mm long needle



CAT. NR.	ORD. NR.	TYPE	NEEDLE LENGTH	NEEDLE THICKNESS (GAUGE)
GIN/00	44879	Standard	1-1/2" (38 mm)	16
* GIN/01	44880	Standard	1-1/2" (38 mm)	18
GIN/02	44881	Standard	1-1/2" (38 mm)	21
GIN/03	44882	Safety	36 mm	18

Key * Best Seller



1,000 PSI
(69 BAR)



FOR HAND OPERATED
GREASE GUNS

34

SEAL OFF DISPENSER

SOD

Used for lubricating cars with grease plugs

Oil & grease resistant rubber tip

Used with grease gun extension or hose



Replacement tip
available as spare

CAT. NR.	ORD. NR.	THREADS
SOD/01/B	44870	1/8" BSPT
SOD/01/N	44871	1/8" NPT
TIP/ SOD/01	44872	(Replacement Tip Only)



FOR HAND OPERATED
GREASE GUNS

35

GREASE GUN HOLDERS

Simple snap action clamps for safe storage of grease guns and suction guns

Mount on almost any surface

Manufactured from heavy gauge steel sheet with zinc plated finish

GGH/01



GGH/02



CAT. NR.	ORD. NR.	SUITABLE FOR BARREL DIAMETER
* GGH/01	44840	2.1/4" (57.15 mm) on guns suitable for 14 oz. (400 gm) cartridge
GGH/02	44841	63.5 mm on guns suitable for 450 gms cartridge popular in Australia & New Zealand

Key * Best Seller

36

HEAVY DUTY GREASE GUN HOLDER

Heavy Duty Grease Gun holder, designed especially for use on farm & construction equipment, trailers, tractors & other automobiles in high vibration environment

Sturdy all steel construction with a 4 bolt design for convenient & secure mounting

Heavy Duty Spring

Works with both 14 oz. (400 gm) capacity Grease Guns with a 2.1/4" (57 mm) dia. and 450 gm capacity Grease Guns with 63.5 mm dia. popular in Australia & New Zealand

4 Bolt Design



* Supplied Without Grease Gun

CAT. NR.	ORD. NR.	SUITABLE FOR BARREL DIAMETER
GGH/03	44842	2.1/4" (57.15 mm) & 63.5 mm barrels popular in Australia & New Zealand

37

GREASE GUN HOSES

Grease hoses allow greasing access to nipples with limited reach. Due to their flexible construction, these are used for greasing hard to reach grease fittings

Thermoplastic construction with 0.14" (3.6 mm) inner diameter & 0.33" (8.5 mm) outer diameter

Highly flexible with minimum bending radius of 1.57" (40 mm)

Zinc plated steel end connections with hydraulic crimping

Select lengths available in the following variations:

- a. Hose fitted with spring guard
- b. Hose fitted with professional 4 jaw coupler with ball check
- c. Hose fitted with Swivel

Other lengths can be custom manufactured

! WARNING

Never use beyond recommended working pressure

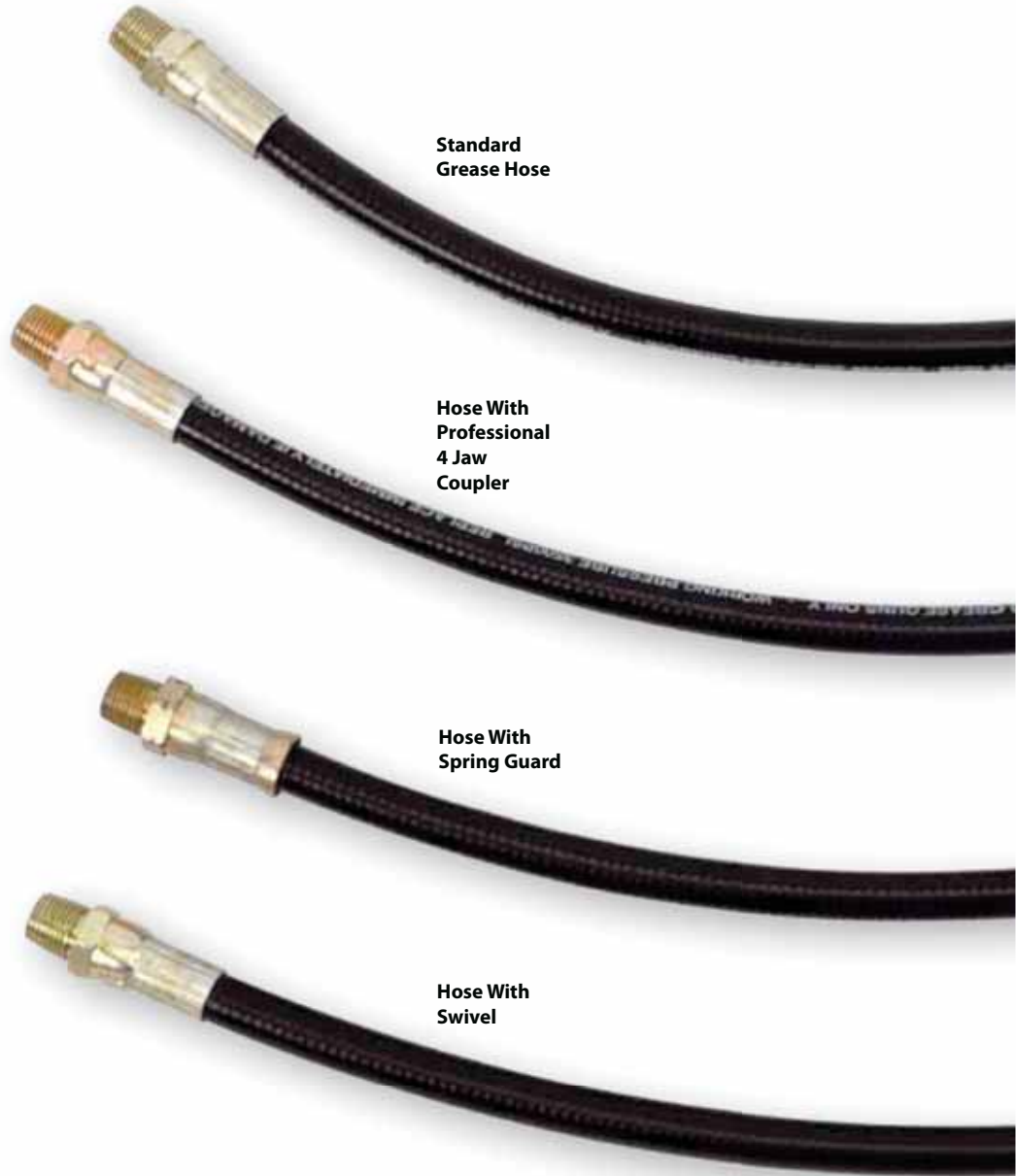

Standard Grease Hose

Hose With Professional 4 Jaw Coupler

Hose With Spring Guard

Hose With Swivel

Standard Grease Hose

CAT. NR.	ORD. NR.	CAT. NR.	ORD. NR.	CAT. NR.	ORD. NR.	LENGTH (END TO END)
1/8" BSPT		M10 X 1		1/8" NPT		
GHC-6/B	43600	GHC-6/M	43610	GHC-6/N	43620	6" (150 mm)
GHC-8/B	43601	GHC-8/M	43611	GHC-8/N	43621	8" (200 mm)
GHC-9/B	43602	GHC-9/M	43612	GHC-9/N	43622	9" (225 mm)
GHC-10/B	43603	GHC-10/M	43613	GHC-10/N	43623	10" (250 mm)
* GHC-12/B	43604	* GHC-12/M	43614	* GHC-12/N	43624	12" (300 mm)
* GHC-18/B	43605	* GHC-18/M	43615	* GHC-18/N	43625	18" (450 mm)
GHC-20/B	43606	* GHC-20/M	43616	GHC-20/N	43626	20" (500 mm)

Key * Best Seller

Hose With Professional 4 Jaw Coupler

CAT. NR.	ORD. NR.	LENGTH (END TO END)	THREADS
* GHC-12/HC/14/4/B	43630	12" (300mm)	1/8" BSPT
GHC-18/HC/14/4/B	43631	18" (450 mm)	1/8" BSPT
* GHC-12/HC/14/4/M	43640	12" (300mm)	M10 x 1
GHC-18/HC/14/4/M	43641	18" (450 mm)	M10 x 1
* GHC-12/HC/14/4/N	43650	12" (300mm)	1/8" NPT
* GHC-18/HC/14/4/N	43651	18" (450 mm)	1/8" NPT

GHC



WORKING PRESSURE
3,500 PSI (240 BAR)

BURST PRESSURE
11,600 PSI (800 BAR)



**FOR HAND OPERATED
GREASE GUNS**

Hose fitted with
Professional
4 Jaw Coupler
with Ball Check

Hose fitted with heavy duty
spring guard that imparts
rigidity to the coupling end
of the hose, allowing added
safety & convenience in
fitment

Hose fitted
with swivel

**USEFUL TIPS!**

**Always buy a good quality hose.
Accidents caused by poor quality
hose can cause fatal injury**

Hose With Spring Guard

CAT. NR.	ORD. NR.	LENGTH (END TO END)	THREADS
GHC-12/SPR/B	43660	12" (300mm)	1/8" BSPT
GHC-18/SPR/B	43661	18" (450 mm)	1/8" BSPT
GHC-12/SPR/M	43670	12" (300mm)	M10 x 1
GHC-18/SPR/M	43671	18" (450 mm)	M10 x 1
* GHC-12/SPR/N	43680	12" (300mm)	1/8" NPT
* GHC-18/SPR/N	43681	18" (450 mm)	1/8" NPT

Hose With Swivel

CAT. NR.	ORD. NR.	LENGTH (END TO END)	THREADS
GHC-12/SW/B	43685	12" (300mm)	1/8" BSPT
GHC-18/SW/B	43688	18" (450 mm)	1/8" BSPT
GHC-12/SW/M	43686	12" (300mm)	M10 x 1
GHC-18/SW/M	43689	18" (450 mm)	M10 x 1
GHC-12/SW/N	43687	12" (300mm)	1/8" NPT
GHC-18/SW/N	43690	18" (450 mm)	1/8" NPT

38

GREASE GUN HOSES - HEAVY DUTY

Superior Construction – Inner tubing is polyamide with polyurethane sheathing, reinforced diagonally in highly tear resistant polyester

Hose has an inner diameter of 0.16" (4.1 mm) & an outer diameter of 0.425" (10.8 mm). **Large inner diameter makes them ideal for use in cold weather**

Heavy duty zinc plated end connections hydraulically crimped to the hose

Rolled threads for extra strength

Select lengths also available in the following variations

- a. Hose fitted with heavy-duty spring guard. Used primarily with Grease Control Valves
- b. Hose fitted with professional 4 jaw coupler with ball check

Other lengths can be custom manufactured

! WARNING

Never use beyond recommended working pressure

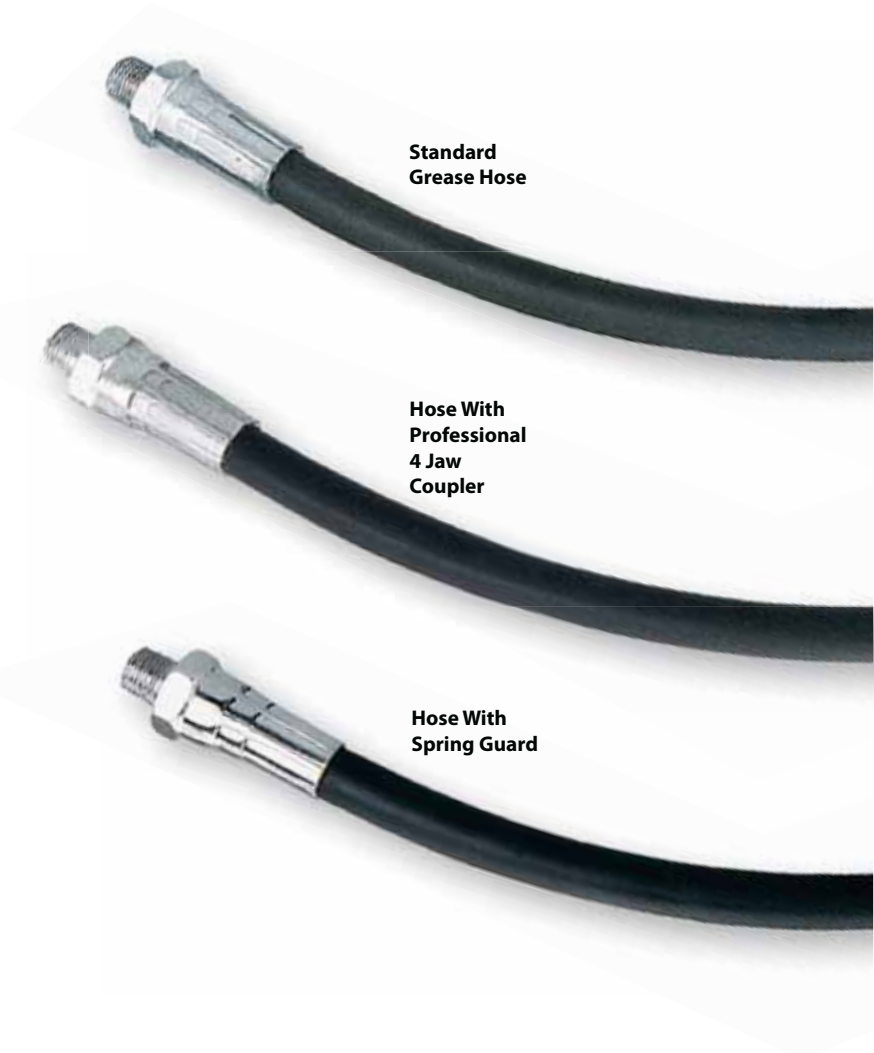

Standard Grease Hose

CAT. NR.	ORD. NR.	LENGTH (END TO END)	THREADS
* GHC/HP-12/B	43700	12" (300 mm)	1/8" BSPT
* GHC/HP-18/B	43701	18" (450 mm)	1/8" BSPT
GHC/HP-20/B	43702	20" (500 mm)	1/8" BSPT
* GHC/HP-12/M	43710	12" (300 mm)	M10 x 1
* GHC/HP-18/M	43711	18" (450 mm)	M10 x 1
* GHC/HP-20/M	43712	20" (500 mm)	M10 x 1
GHC/HP-12/N	43720	12" (300 mm)	1/8" NPT
* GHC/HP-18/N	43721	18" (450 mm)	1/8" NPT
* GHC/HP-20/N	43722	20" (500 mm)	1/8" NPT

Key * Best Seller

GHC-HP



WORKING PRESSURE
5,800 PSI (400 BAR)

BURST PRESSURE
13,775PSI (950 BAR)

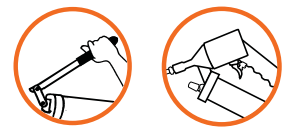

**FOR HAND AND AIR OPERATED
GREASE GUNS**

Hose fitted with
Professional
4 Jaw Coupler
with Ball Check

Hose fitted with
heavy-duty spring guard.
Used primarily with grease
control valves

**USEFUL TIPS!**

Always buy a good quality hose.
Accidents caused by poor quality
hose can cause fatal injury

Hose with Professional 4 Jaw Coupler

CAT. NR.	ORD. NR.	LENGTH (END TO END)	THREADS
* GHC/HP-12/HC/14/4/B	43730	12" (300 mm)	1/8" BSPT
* GHC/HP-18/HC/14/4/B	43731	18" (450 mm)	1/8" BSPT
* GHC/HP-12/HC/14/4/M	43740	12" (300 mm)	M10 x 1
* GHC/HP-18/HC/14/4/M	43741	18" (450 mm)	M10 x 1
* GHC/HP-12/HC/14/4/N	43750	12" (300 mm)	1/8" NPT
* GHC/HP-18/HC/14/4/N	43751	18" (450 mm)	1/8" NPT

Hose with Spring Guard

CAT. NR.	ORD. NR.	LENGTH (END TO END)	THREADS
GHC/HP-12/SPR/B	43760	12" (300 mm)	1/8" BSPT
GHC/HP-18/SPR/B	43761	18" (450 mm)	1/8" BSPT
GHC/HP-12/SPR/M	43770	12" (300 mm)	M10 x 1
GHC/HP-18/SPR/M	43771	18" (450 mm)	M10 x 1
* GHC/HP-12/SPR/N	43780	12" (300 mm)	1/8" NPT
* GHC/HP-18/SPR/N	43781	18" (450 mm)	1/8" NPT

39

FLEXIBLE / RIGID GREASE GUN EXTENSION

Grease Gun Extension that works as a firm & rigid 13" (330 mm) long steel extension or converts into a flexible hose extension for greasing hard to reach fittings

Switches with one hand by a simple slide of the steel tube

Supplied complete with Grease Gun Coupler

Ideal for use with Grease Control valves

Push to convert from rigid to flexible extension



CAT. NR.	ORD. NR.	THREADS
FRC/13/B	44810	1/8" BSPT
FRC/13/M	44811	M10 x 1
* FRC/13/N	44812	1/8" NPT

Key * Best Seller

SWITCHES WITH ONE HAND

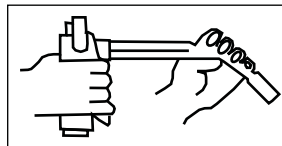

WORKING PRESSURE
5,000 PSI (345 BAR)



FOR HAND AND AIR OPERATED
GREASE GUNS

40

GREASE GUN EXTENSION SWIVEL

Grease Gun extension swivel threaded 1/8" Male x 1/8" Female

Female end of the swivel fits onto the Grease Gun extension & male end onto the Grease Gun outlet, enabling unrestricted movement without any bending, twisting or kink

All steel construction in plated finish

CAT. NR.	ORD. NR.	THREADS
SWV/1-8M/1-8F/B	44885	1/8" BSPT
SWV/1-8M/1-8F/M	44886	M10 x 1
SWV/1-8M/1-8F/N	44887	1/8" NPT



MAX. WORKING PRESSURE
3,500 PSI (240 BAR)



FOR HAND OPERATED
GREASE GUNS

41

GREASE GUN STEEL
EXTENSIONS

Steel construction with bright zinc plated finish

High strength rolled threads on both ends

Available in straight & bent construction

CAT. NR.	ORD. NR.	LENGTH (END TO END)	THREADS
BENT			
GBP/6/B	44800	6" (150 mm)	1/8" BSPT
GBP/6/M	44801	6" (150 mm)	M10 X 1
GBP/6/N	44802	6" (150 mm)	1/8" NPT
GBP/8/M	44804	8" (200 mm)	M10 X 1
GBP/18/N	44809	18" (450 mm)	1/8" NPT
STRAIGHT			
GSP/4/B	44820	4" (100 mm)	1/8" BSPT
GSP/4/M	44821	4" (100 mm)	M10 X 1
GSP/4/N	44822	4" (100 mm)	1/8" NPT
GSP/5/N	44823	5" (125 mm)	1/8" NPT
GSP/6/B	44827	6" (150 mm)	1/8" BSPT
GSP/6/N	44829	6" (150 mm)	1/8" NPT
GSP/8/M	44817	8" (200 mm)	M10 X 1



42

GREASE GUN LIGHT

NEW!

Extremely useful accessory for grease guns

Makes it easy to locate grease fittings in dark areas, shoulders & other difficult to locate points

Slim construction with a powerful LED

Fits both on grease gun steel extensions & flexible hoses with ease

Includes 3 LR 41 button cells

CAT. NR.	ORD. NR.
LED/GGL/01	55015



43

BULK LOADERS / FILLER NIPPLES

Spare loader valves for bulk loading grease guns using Filler pump

Built in Ball Check

Zinc plated finish



CAT. NR.	ORD. NR.	CAT. NR.	ORD. NR.	CAT. NR.	ORD. NR.	TYPE
1/8" BSPT		M10 X 1		1/8" NPT		
● BLV/01/B	44830	● BLV/01/M	44833	BLV/04/N	44835	Straight
BLV/02/B	44831			● BLV/02/N	44834	Tapered
				BLV/06/N	44836	Tapered

Key ● Used on GROZ Grease Guns as standard

44

AIR RELEASE VALVES

Spare bleeder fitting for grease guns

Available in Manual & Automatic versions

Vents air pockets in grease guns efficiently

Zinc plated finish

CAT. NR.	ORD. NR.	THREADS
MANUAL		
ARV/01/B	44839	1/8" BSPT
ARV/01/M	44837	M10 x 1
ARV/01/N	44838	1/8" NPT
AUTOMATIC		
◆ SA/ARV/G70/B	44897	1/8" BSPT
◆ SA/ARV/G70/M	44898	M10 x 1
◆ SA/ARV/G70/N	44899	1/8" NPT

Key ◆ New



Press down to release trapped air in grease

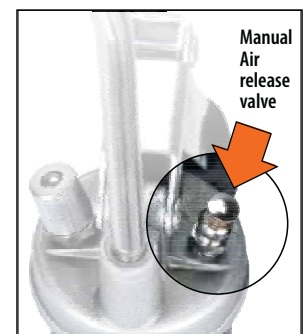

45

DELUXE STEEL BEARING PACKERS

BEP-01

BEP-625

Useful for greasing bearings in cars, boats, tractors, RV's etc

Rugged steel construction



USEFUL TIPS!

Always use recommended grade of grease. Some grades of grease cannot handle temperatures of wheel bearing applications

Do not use compressed air for cleaning the bearing prior to use with the bearing packer. This is unsafe and could damage the race



BEP-625

Rapid action Bench Type Bearing Packer for use with Grease Guns. Non threaded top cone for fast placement of bearings. The design incorporates grease nipple on the outer shaft, which easily adapts to the grease gun coupler. Suited for bearings with a min. inner diameter of 1/2" (12 mm), to a max. outer diameter of 6" (150 mm) and height from 3/8" (10 mm) to 2" (50 mm)



BEP-01

Bearing Packer with threaded center post for use with Grease Guns. The design incorporates grease nipple at one end, which easily adapts to the grease gun coupler. Suited for bearings with a min. inner diameter of 1/2" (12 mm), to a max. outer diameter of 5" (125 mm) and height from 1/4" (6 mm) to 2" (50 mm)



BEP/625WB

Rapid action Bearing Packer for use with Grease Gun Filler Pump. Non threaded top cone for fast placement of bearings. Outer shaft is threaded 1/4" NPT (F) & fits onto the Outlet Discharge Tube of the Grease Filler Pump. Suited for bearings with a min. inner diameter of 1/2" (12 mm), to a max. outer diameter of 6" (150 mm) and height from 3/8" (10 mm) to 2" (50 mm)

CAT. NR.	ORD. NR.	DESCRIPTION
BEP/01	44845	For use with Grease Guns
BEP/625	44847	For use with Grease Guns
BEP/625WB	44848	For use with Filler Pump

46

GREASE FEEDERS

Grease Feeders are used to provide single point controlled lubrication for all types of bearing housings thereby eliminating difficulties arising due to over or under greasing

Working on a spring compression mechanism, the design regulates grease discharge in proportion to changing spring pressure, thus maintaining constant discharge pressure of 1- 2 PSI

Assembled with medium duty spring, the light & heavy duty springs come as spares in the pack and can be easily interchanged depending upon application

Can be mounted in any position for easy visual inspection of grease levels

Reusable: Can be refilled easily with immediate activation.

1/8" (M) steel adaptor at the tail end fits directly onto bearing housings Thread converters & angle adaptors available as spares

Remote Refill kit also available that permits remote filling of grease from distances up to 3 meters (10')

RECOMMENDED USE

For use with NLGI 0 to 4 non separating grease on any equipment that

- has anti friction, oscillating or roller bearings
- has shielded bearings with seals
- has bronze, olite or open bearings
- requires bearing flushing action



GFD/PP

! WARNING

Do not use with ESTER based greases, synthetic greases such as Aeroshell 33 Grease, Aeroshell 7 Grease, Skydrol Products etc. These have an adverse effect on polycarbonate & can cause fogging , cracking & fracturing

Dome	Polycarbonate
Base	Polycarbonate
Temperature	-23°C to 121°C (-10°F to 250°F)
Application	Static Non Vibratory Conditions

CAT. NR.	ORD. NR.	CAT. NR.	ORD. NR.	BOWL CAPACITY	OPERATING CONDITION	OVERALL DIA.	OVERALL HEIGHT
1/8" BSPT THREADS		1/8" NPT THREADS					
POLYCARBONATE BOWL & BASE							
GFD/PP/1/B	47700	GFD/PP/1/N	47720	1 oz. (28 gms)	Static	1-3/4" (45 mm)	3-5/8" (92 mm)
GFD/PP/2/B	47701	GFD/PP/2/N	47721	2 oz. (56 gms)	Static	2-3/8" (60 mm)	4-5/8" (117 mm)
GFD/PP/6/B	47702	GFD/PP/6/N	47722	6 oz. (170 gms)	Static	3" (75 mm)	6" (150 mm)
POLYCARBONATE BOWL & ALUMINIUM BASE							
GFD/PA/1/B	47703	GFD/PA/1/N	47723	1 oz. (28 gms)	Dynamic	1-3/4" (45 mm)	3-5/8" (92 mm)
GFD/PA/2/B	47704	GFD/PA/2/N	47724	2 oz. (56 gms)	Dynamic	2-3/8" (60 mm)	4-5/8" (117 mm)
GFD/PA/6/B	47705	GFD/PA/6/N	47725	6 oz. (170 gms)	Dynamic	3" (75 mm)	6" (150 mm)
POLYCARBONATE BOWL & NICKEL PLATED ALUMINIUM BASE							
GFD/PAN/1/B	47706	GFD/PAN/1/N	47726	1 oz. (28 gms)	Corrosive	1-3/4" (45 mm)	3-5/8" (92 mm)
GFD/PAN/2/B	47707	GFD/PAN/2/N	47727	2 oz. (56 gms)	Corrosive	2-3/8" (60 mm)	4-5/8" (117 mm)
GFD/PAN/6/B	47708	GFD/PAN/6/N	47728	6 oz. (170 gms)	Corrosive	3" (75 mm)	6" (150 mm)
BOROSILICATE BOWL & ALUMINIUM BASE							
GFD/BA/4/B	47709	GFD/BA/4/N	47729	4 oz. (113 gms)	High Temperature / Nuclear Environments	3-1/4" (82 mm)	7-1/8" (181 mm)
REMOTE GREASE REFILL KIT							
GFD/RK/1	47790	3 m (10') Grease Hose with all fittings					



GFD/PP



GFD/PAN



GFD/PA



GFD/BA



GFD/PA

Dome	Polycarbonate
Base	Die Cast Aluminium
Temperature	-23°C to 121°C (-10°F to 250°F)
Application	Dynamic applications involving vibration & shocks



GFD/PAN

Dome	Polycarbonate
Base	Die Cast Aluminium with Nickel Plating
Temperature	-23°C to 121°C (-10°F to 250°F)
Application	Corrosive environments for dynamic applications involving vibrations & shocks: chemical plants, food industry etc.



GFD/BA

Dome	Tempered borosilicate with stainless steel cap
Base	Aluminium
Temperature	-23°C to 232°C (-10°F to 450°F)
Application	Very high temperature applications: nuclear plants, steel mills, lumber drying kilns etc.

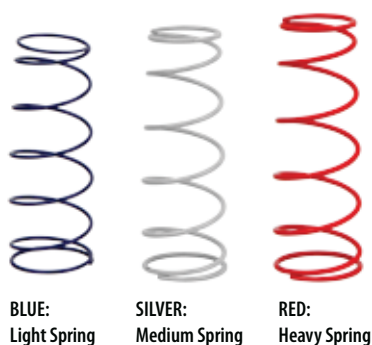

BLUE: Light Spring

SILVER: Medium Spring

RED: Heavy Spring

SPRING SELECTION GUIDE

Operating Temperature		NLGI Grease Type				
From	To	No. 0	No. 1	No. 2	No. 3	No. 4
-23°C (-10°F)	4°C (40°F)	Blue	Silver	Red		
4°C (40°F)	43°C (110°F)	Blue	Silver	Silver	Red	
43°C (110°F)	93°C (200°F)		Blue	Silver	Silver	Red
93°C (200°F)	121°C (250°F)			Blue	Silver	Red



Remote Grease Refill Kit

SIZE SELECTION GUIDE

Bearing Shaft Dia.	Upto 1-1/2" (38 mm)				1-1/2" (38 mm) & over			
	Intermittent		Continuous		Intermittent		Continuous	
Operating Condition	Open	Sealed	Open	Sealed	Open	Sealed	Open	Sealed
Class of Bearing								
Under 1000 RPM	1 oz.	1 oz.	1 oz.	1 oz.	2 oz.	2 oz.	2 oz.	2 oz.
1000 to 2500 RPM	1 oz.	1 oz.	1 oz.	1 oz.	2 oz.	2 oz.	6 oz.	6 oz.
Over 2500 RPM	2 oz.	1 oz.	2 oz.	2 oz.	6 oz.	6 oz.	6 oz.	6 oz.



**6,000 PSI
(413 BAR)**

Manufactured to the most stringent quality standards – TS16949 approved manufacturing

Available in a range of materials: EN-1A steel, 303 Stainless Steel, Brass etc.

Fitting profile & dimensions are accurately controlled & conform to SAE, DIN, BS, JIS & IS standards

Grease fittings are heat treated to SAE J534 specification with hardness on greasing end to a minimum of 83 on Rockwell 15N scale with a case depth of 0.005" (0.13 mm) to 0.009" (0.23 mm)

Fittings with ball check use heat treated springs for increased life

Steel fittings are plated in yellow zinc with a plating thickness of 0.0002" (5 microns) conforming to SAE J534 specification & have a guaranteed salt spray life of over 75 hours to red rust. Fittings can be custom manufactured in white zinc & also be made with trivalent passivation

Also available 303 stainless steel fittings for marine applications

Available ready from stock in a large selection of popular types & sizes, with many more variations custom manufactured



CAT. NR.	ORD. NR.	DESCRIPTION	DIMENSIONS (FOR GUIDANCE ONLY)			
			EFFECTIVE THREAD LENGTH	SHANK LENGTH	OVERALL LENGTH	HEX SIZE
1/4" - 28 SAE-LT - TAPER THREAD						
* GFT/1-4/28	46000	Straight	2.5 mm min.	4.6 mm	13.7 mm	5/16"
GFT/1-4/28L	46002	Straight	5.1 mm min.	8.6 mm	17.3 mm	5/16"
* GFT/1-4/28/45	46003	45°	2.5 mm min.	5.1 mm	20.8 mm	3/8"
GFT/1-4/28/65	46005	65°	2.5 mm min.	5.1 mm	18.5 mm	3/8"
* GFT/1-4/28/90	46006	90°	2.5 mm min.	5.1 mm	19.3 mm	3/8"
1/4" - 28 SPL. SELF FORMING THREADS						
GFT/1-4/28/SFT	46030	Straight	2.5 mm min.	5.1 mm	14.0 mm	5/16"
GFT/1-4/28/45/SFT	46031	45°	2.5 mm min.	4.8 mm	20.3 mm	3/8"
GFT/1-4/28/90/SFT	46032	90°	2.5 mm min.	4.8 mm	19.3 mm	3/8"
1/8" X 28 BSPT - TAPER THREADS						
* GFT/R/1-8/28	46113	Straight	3.75 mm	5.5 mm	16.0 mm max.	11.0 mm
GFT/R/1-8/28L	46116	Straight	6.5 mm	8.0 mm	20.0 mm max.	11.0 mm
* GFT/R/1-8/28/45	46114	45°	3.75 mm	5.5 mm	21.0 mm max.	11.0 mm
GFT/R/1-8/28/45L	46117	45°	6.5 mm	8.0 mm	26.3 mm	11.0 mm
* GFT/R/1-8/28/90	46115	90°	3.75 mm	5.5 mm	18.0 mm	11.0 mm
GFT/R/1-8/28/90L	46118	90°	6.5 mm	8.0 mm	21.4 mm	11.0 mm
1/4" X 19 BSPT - TAPER THREADS						
GFT/R/1-4/19	46103	Straight	4.2 mm	6.5 mm	17.5 mm	9/16"
GFT/R/1-4/19/L	46106	Straight	9.2 mm	10.7 mm	23.5 mm	0.60"
GFT/R/1-4/19/45	46104	45°	4.2 mm	6.5 mm	22.5 mm	9/16" or 14 mm
GFT/R/1-4/19/90	46105	90°	4.2 mm	6.5 mm	22.0 mm	9/16" or 14 mm
UNF - PARALLEL THREADS						
GFT/1-4/28-UNF	46500	Straight 1/4"-28	2.5 mm min.	4.6 mm	15.0 mm	8.0 mm
GFT/5-16/24-UNF	46501	Straight 5/16"-24	4.0 mm min.	6.35 mm	16.7 mm	7/16"
GFT/3-8/24-UNF	46503	Straight 3/8"-24	4.4 mm min.	6.8 mm	16.7 mm	7/16"
BSF - PARALLEL THREADS						
GFT/1-4/26-BSF	46520	Straight 1/4"-26	2.0 mm min.	4.6 mm	13.9 mm	7.0 mm
GFT/5-16/22-BSF	46521	Straight 5/16"-22	2.5 mm min.	5.5 mm	15.0 mm	9.0 mm
GFT/3-8/20-BSF	46522	Straight 3/8"-20	3.7 mm min.	5.5 mm	18.0 mm max.	11.0 mm
1/8" - 27 PIPE THREADS PT-F - SPECIAL SHORT						
GFT/1-8/27S	46046	Straight	4.0 mm min.	5.95 mm	14.3 mm	7/16"
* GFT/1-8/27	46035	Straight	4.6 mm min.	7.1 mm	16.8 mm	7/16"
GFT/1-8/27L	46037	Straight	5.6 mm min.	19.3 mm	32.0 mm	7/16"
GFT/1-8/27/30	46040	30°	5.6 mm min.	7.6 mm	22.9 mm	7/16"
* GFT/1-8/27/45	46041	45°	5.6 mm min.	7.6 mm	21.8 mm	7/16"
* GFT/1-8/27/65	46042	65°	5.6 mm min.	7.6 mm	21.8 mm	7/16"
* GFT/1-8/27/90	46044	90°	5.6 mm min.	7.6 mm	21.3 mm	7/16"
1/8" - 27 SPL. SELF FORMING THREADS						
GFT/1-8/27/SFT	46070	Straight	3.6 mm min.	6.1 mm	15.7 mm	7/16"
GFT/1-8/27/45/SFT	46071	45°	2.8 mm min.	5.1 mm	19.8 mm	7/16"
GFT/1-8/27/90/SFT	46072	90°	2.8 mm min.	5.1 mm	19.3 mm	7/16"

Key * Best Seller

Grease Fittings
StraightGrease Fitting
Angled -45°Grease Fitting
Angled -90°Grease Fitting
Pin TypeButton Head
Grease Fitting

CAT. NR.	ORD. NR.	DESCRIPTION	DIMENSIONS (FOR GUIDANCE ONLY)			
			EFFECTIVE THREAD LENGTH	SHANK LENGTH	OVERALL LENGTH	HEX SIZE
1/4" - 18 PIPE THREADS - SPECIAL EXTRA SHORT						
* GFT/1-4/18	46020	Straight	6.0 mm min.	10.7 mm	22.0 mm	9/16"
GFT/1-4/18/45	46022	45°	5.75 mm min.	9.27 mm	29.74 mm	9/16"
* GFT/1-4/18/65	46021	65°	5.6 mm min.	8.7 mm	24.6 mm	9/16"
GFT/1-4/18/90	46023	90°	5.75 mm min.	9.27 mm	24.0 mm	9/16"
6.0 MM X 1.0 MM TAPER THREADS						
* GFT/6/1	46200	Straight	3.75 mm min.	5.5 mm max.	16.0 mm max.	7.0 mm
* GFT/6/1/45	46201	45°	4.5 mm min.	5.5 mm max.	21.0 mm max.	9.0 mm
* GFT/6/1/90	46202	90°	4.5 mm min.	5.5 mm max.	18.0 mm max.	9.0 mm
8.0 MM X 1.0 MM TAPER THREADS						
* GFT/8/1	46220	Straight	5.5 mm min.	6.5 mm max.	16.0 mm max.	9.0 mm
* GFT/8/1/45	46222	45°	3.75 mm min.	5.5 mm max.	21.0 mm max.	9.0 mm
* GFT/8/1/90	46223	90°	3.75 mm min.	5.5 mm max.	18.0 mm max.	9.0 mm
8.0 MM X 1.25 MM TAPER THREADS						
GFT/8/1.25	46221	Straight	3.75 mm min.	5.5 mm max.	17.0 mm max.	9.0 mm
GFT/8/1.25/45	46224	45°	3.7 mm min.	5.5 mm max.	21.0 mm max.	9.0 mm
GFT/8/1.25/90	46225	90°	3.7 mm min.	5.5 mm max.	18.0 mm max.	9.0 mm
10.0 MM X 1 MM TAPER THREADS						
* GFT/10/1	46230	Straight	3.75 mm min.	5.5 mm max.	16.0 mm max.	11.0 mm
* GFT/10/1/45	46231	45°	3.75 mm min.	5.5 mm max.	21.0 mm max.	11.0 mm
* GFT/10/1/90	46232	90°	3.75 mm min.	5.5 mm max.	18.0 mm max.	11.0 mm
10.0 MM X 1.5 MM TAPER THREADS						
GFT/10/1.5	46240	Straight	3.75 mm min.	5.5 mm max.	18.0 mm max.	11.0 mm
GFT/10/1.5/45	46241	45°	3.75 mm min.	5.5 mm max.	21.0 mm max.	11.0 mm
GFT/10/1.5/90	46242	90°	3.75 mm min.	5.5 mm max.	18.0 mm max.	11.0 mm
DRIVE FITTINGS						
GFT/DF/3-16	46300	For 3/16" Drill	N.A	6.35 mm	13.1 mm	Dia. 5/16" (7.94 mm)
* GFT/DF/1-4	46304	For 1/4" Drill	N.A	6.35 mm	13.9 mm	Dia. 11/32" (8.73 mm)
GFT/DF/5-16	46302	For 5/16" Drill	N.A	6.35 mm	13.9 mm	Dia. 3/8" (9.53 mm)
BUTTON HEAD GREASE FITTING - PARALLEL THREADS						
GFT/BHC/1-4/19	46400	1/4" x 19 BSPF	7.0 mm min	10.7 mm	21.0 mm	15.24 mm
GFT/BHC/1-8/28	46401	1/8" x 28 BSPF	4.0 mm min.	7.4 mm	15.3 mm	15.24 mm
BUTTON HEAD GREASE FITTING - TAPER THREADS						
GFT/BHC/1-8/27	46420	1/8" - 27 PTF SAE spl. Short	4.76 mm min.	8.7 mm	19.0 mm	5/8"
GFT/BHC/3-8/18	46421	3/8" - 18 NPTF	9.5 mm min.	12.3 mm	24.2 mm	3/4"
GFT/BHC/1-4/18	46422	1/4" - 18 NPTF	6.75 mm min.	10.7 mm	21.0 mm	5/8"
GREASE FITTINGS - PIN TYPE - BRASS CONSTRUCTION						
GN/PN/1-8	43901	1/8" BSPT	7.0 mm	8.0 mm	27.0 mm	10.0 mm
GN/PN/1-4	43900	1/4" BSPT	10.0 mm	11.0 mm	30.0 mm	14.0 mm
GN/PN/1-8/N	43903	1/8" NPT	7.0 mm	8.0 mm	27.0 mm	10.0 mm
GN/PN/1-4/N	43902	1/4" NPT	10.0 mm	11.0 mm	30.0 mm	14.0 mm
STAINLESS STEEL GREASE FITTINGS						
GFT/SS/1-4/28	46600	Straight, 1/4" - 28 SAE LT	2.5 mm min.	4.6 mm	13.7 mm	5/16"
GFT/SS/1-4/28/45	46601	45°, 1/4" - 28 SAE LT	2.5 mm min.	5.1 mm	20.8 mm	3/8"
GFT/SS/1-4/28/90	46602	90°, 1/4" - 28 SAE LT	2.5 mm min.	5.1 mm	19.3 mm	3/8"
GFT/SS/1-8/27	46610	Straight, 1/8" - 27 PTF	4.6 mm min.	7.1 mm	16.8 mm	7/16"
GFT/SS/1-8/27/45	46611	45°, 1/8" - 27 PTF	5.6 mm min.	7.6 mm	21.8 mm	7/16"
GFT/SS/1-8/27/90	46612	90°, 1/8" - 27 PTF	5.6 mm min.	7.6 mm	21.3 mm	7/16"
GFT/SS/1-4/18	46620	Straight, 1/4" - 18 PTF	6.0 mm min.	10.7 mm	22.0 mm	9/16"
GFT/SS/6/1	46630	Straight, M6 x 1	3.75 mm min.	5.5 mm max.	16.0 mm max.	7.0 mm
GFT/SS/1-8/28	46640	Straight, 1/8" - 28 BSPT	3.75 mm min.	5.5 mm max.	16.0 mm max.	11.0 mm

48

GREASE FITTING SETS

GFT/KIT/BSPT-50 43976

50 pcs of BSPT Grease Fittings packed to a plastic box

THREAD SPEC.	STRAIGHT	45°	90°
1/8"-28 BSPT	20	5	5
1/4"-19 BSPT	10	5	5



GFT/KIT/M-44 43981

44 pcs of Metric Grease Fittings packed to a plastic box

THREAD SPEC.	STRAIGHT	45°	90°
M6 x 1	10	6	6
M8 x 1	6		6
M10 x 1	10		



GFT/KIT/SS/SAE-40 43982

40 pcs of Stainless Steel SAE Grease Fittings packed to a plastic box

THREAD SPEC.	STRAIGHT	45°	90°
1/8"-27 PTF	10	5	5
1/4"-28 SAE-LT	10	5	5



GFT/KIT/SAE-110 43970

110 pcs of SAE Grease Fittings packed to a plastic box

THREAD SPEC.	STRAIGHT	45°	90°
1/8"-27 PTF	30	15	15
1/4"-28 SAE-LT	20	15	15

GFT/KIT/M-110 43971

110 pcs of Metric Grease Fittings packed to a plastic box

THREAD SPEC.	STRAIGHT	90°
M6 X 1	30	20
M8 X 1	20	10
M10 X 1	20	10



GFT/KIT/SAE-80 43972

* 80 pcs of SAE Grease Fittings packed to a plastic box

THREAD SPEC.	STRAIGHT	45°	90°
1/8"-27 PTF	25	10	10
1/4"-28 SAE-LT	15	10	10

GFT/KIT/M-80 43973

* 80 pcs of Metric Grease Fittings packed to a plastic box

THREAD SPEC.	STRAIGHT	90°
M6 X 1	20	10
M8 X 1	15	10
M10 X 1	15	10



Key * Best Seller

GFT/ESO/KIT/SAE-101 43977

* 101 pcs of SAE Grease Fittings & Grease Fitting Tools packed to a plastic box

THREAD SPEC.	STRAIGHT	30°	45°	65°	90°
1/8"-27 PTF	22	5	10	10	10
1/4"-28 SAE-LT	22		10		10
ESO/1, Easy Out Tool (Small)		1			
ESO/2, Easy Out Tool (Large)		1			

Key * Best Seller

GFT/ESO/KIT/M-101 43978

* 101 pcs of Metric Grease Fittings & Grease Fitting Tools packed to a plastic box

THREAD SPEC.	STRAIGHT	45°	90°
M6 X 1	30	5	10
M8 X 1	14		5
M10 X 1	20	5	10
ESO/1, Easy Out Tool (Small)		1	
ESO/2, Easy Out Tool (Large)		1	

**GFT/GC/KIT/SAE-100 43980**

100 pcs of SAE Grease Fittings & Caps packed to a plastic box

THREAD SPEC.	STRAIGHT	45°	90°
1/8"-27 PTF	15	10	10
1/4"-28 SAE-LT	15	10	10
Grease Fitting Caps (Red)		10	
Grease Fitting Caps (Yellow)		10	
Grease Fitting Caps (Black)		10	

GFT/GC/KIT/M-100 43979

100 pcs of Metric Grease Fittings & Caps packed to a plastic box

THREAD SPEC.	STRAIGHT	90°
M6 X 1	15	10
M8 X 1	15	5
M10 X 1	15	10
Grease Fitting Caps (Red)		10
Grease Fitting Caps (Yellow)		10
Grease Fitting Caps (Black)		10

**GFT/GK/SAE-60 43984**

60 pcs of SAE Grease Fittings & Couplers packed to a plastic box

THREAD SPEC.	STRAIGHT	45°	90°
1/8"-27 PTF	15	4	4
1/4"-28 SAE-LT	25	4	4
HC/14/4/N, Prof. 4 Jaw Coupler		1	
HC/12/4/N, HD 4 Jaw Coupler		1	
HC/R/01/N, 90° Coupler		1	
DNN/1-8/N, Needle Nose Dispenser		1	

GFT/GK/M-60 43983

60 pcs of Metric Grease Fittings & Couplers packed to a plastic box

THREAD SPEC.	STRAIGHT	90°
M6 X 1	20	4
M8 X 1	12	4
M10 X 1	12	4
HC/14/4/N, Prof. 4 Jaw Coupler		1
HC/12/4/N, HD 4 Jaw Coupler		1
HC/R/01/N, 90° Coupler		1
DNN/1-8/N, Needle Nose Dispenser		1

**GFT/KIT/ULT/SAE-65 43985**

65 pcs of SAE Grease Fittings & Assortments packed to a plastic box

THREAD SPEC.	STRAIGHT	45°	90°
1/8"-27 PTF	15	5	5
1/4"-28 SAE-LT	15	5	5
ESO/1, Easy Out Tool (Small)		1	
ESO/2, Easy Out Tool (Large)		1	
Grease Fitting Caps (Red)		5	
Grease Fitting Caps (Yellow)		5	
HC/14/4/N, Professional 4 Jaw Coupler		2	
THT/01, Grease Fitting Thread Tester		1	

GFT/KIT/ULT/SM-65 43986

65 pcs of Metric, SAE Grease Fittings & Assortments packed to a plastic box

THREAD SPEC.	STRAIGHT	90°
1/8"-27 PTF	10	5
1/4"-28 SAE-LT	10	5
M6 X 1	10	
M8 X 1	10	
ESO/1, Easy Out Tool (Small)		1
ESO/2, Easy Out Tool (Large)		1
Grease Fitting Caps (Red)		5
Grease Fitting Caps (Yellow)		5
HC/14/4/N, Professional 4 Jaw Coupler		2
THT/01, Grease Fitting Thread Tester		1



Thread Tester

49

GREASING ADAPTORS & ELBOWS

NEW!

Very useful Steel Fittings used to adapt a threaded fitting to a different size Opening thread.

These are made out of Steel & are zinc plated for increased resistance to corrosion.



CAT. NR.	ORD. NR.	THREADS	BODY	ANGLE	SHANK LENGTH	OVERALL LENGTH
ADAPTORS						
ADP/H/1-4F/1-8F	46800	1/8"-27 (F) x 1/4"-28 (F)	Hex	Straight	1/2"	21/32"
ADP/H/1-4M/1-8F	46801	1/8"-27 (F) x 1/4"-28 (M)	Hex	Straight	1/2"	7/8"
ADP/S/1-8M/1-8F	46802	1/8"-27 (F) x 1/8"-27 (M)	Square	Straight	1/2"	7/8"
ELBOWS						
ADP/S/45/1-8M/1-8F	46803	1/8"-27 (F) x 1/8"-27 (M)	Square	45°	1/2"	1"
ADP/R/45/1-4M/1-8F	46804	1/8"-27 (F) x 1/4"-28 (M)	Rounded	45°	1/4"	13/16"
ADP/S/90/1-4M/1-8F	46805	1/8"-27 (F) x 1/4"-28 (M)	Square	90°	1/2"	13/16"
ADP/S/90/1-8M/1-8F	46806	1/8"-27 (F) x 1/8"-27 (M)	Square	90°	1/2"	1"



6,000 PSI
(413 BAR)



FOR HAND OPERATED
GREASE GUNS

50

GREASE FITTING THREAD TESTER

THT

Great tool box accessory to sort out mixed fittings

Aluminum construction with mounting holes

DESIGNED TO CHECK 21 MOST POPULAR THREAD TYPES:

THREAD TYPE	SIZE		
	1/8"	1/4"	3/8"
NPT	1/8"	1/4"	3/8"
METRIC	M6 X 1	M6 X 0.75	
METRIC	M8 X 1	M8 X 1.25	
METRIC	M10 X 1	M10 X 1.5	
BSPT	1/8"	1/4"	
UNF/ANF	1/4"	5/16"	3/8"
BSW	1/4"	5/16"	1/2" 3/8"
BSF	3/16"	1/4"	5/16"



CAT. NR.	ORD. NR.
THT/01	44895

51

GREASE FITTING CAPS

Plastic Caps for Grease fittings are an easy way to keep contaminants out. These additionally help in colour coding the greasing points based on frequency of greasing or type of grease

Designed with an inbuilt collar, these are most convenient in use & fit directly onto the greasing end of the fitting

Made from a special plastic, these adjust to minor variations in fitting head diameter, as well as variations in temperature & practically fit all standard fittings designed for use with jaw type couplers

Available in Black, Red, Yellow, Blue, White & Green as standard with other colours that can be custom manufactured

Sold in packs of 50



CAT. NR.	ORD. NR.	COLOUR
CAP/GFT/BL/ST-50	46700	Black
CAP/GFT/RD/ST-50	46701	Red
CAP/GFT/YE/ST-50	46702	Yellow
◆ CAP/GFT/BU/ST-50	46703	Blue
◆ CAP/GFT/WH/ST-50	46704	White
CAP/GFT/GN/ST-50	46705	Green

Key ◆ New



52

EASY OUT TOOLS

ESO

Handy, dual purpose tools for removing worn & broken grease fittings as well as re-tapping holes for installing new grease fittings

Works with straight & angled fittings

Available in small & large sizes for use on almost all threaded fittings



CAT. NR.	ORD. NR.	TYPE	OPENS FITTINGS WITH HEX SIZE	TAP RETHREADS
* ESO/1	44890	Small	5/16" & 3/8"	1/4" - 28
* ESO/2	44891	Large	3/8" & 7/16" (11 mm)	1/8" - 27

Key * Best Seller

53

"DRIVE FIT" GREASE FITTING INSTALLER

Specialty tools for installing straight & angled Drive-Fit Grease fittings into untapped holes

Steel construction in zinc plated finish



CAT. NR.	ORD. NR.	FOR FITTING TYPE
FTS/01	44892	Straight
FTA/01	44893	Angled

54

GREASE FITTING UNBLOCKER

GFU

Opens clogged grease fittings and loosens hardened grease joints

Excellent for maintaining and protecting bearings, control arms, joints, king pins, etc.

Tool has an all steel construction & is designed to be tapped with a hammer to force a light viscosity oil through the tool into the coupler & finally into the grease joint, breaking up and removing dirt and debris

Built-In Hand Guard for added safety in use

Flexible hose attachment reaches fittings in difficult areas

Comes complete with grease coupler and 2 spare seals for replacing the piston seals as they wear out



CAT. NR.	ORD. NR.
GFU/01	44894

QUICK CONNECTION SYSTEM

*Quick Connect!
Connect or disconnect
with a snap!*

A simple and effective system that renders versatility to Grease Guns

Greasing in inaccessible, difficult to reach areas becomes very convenient with the use of any of the Quick Link accessories. No threads, no screwing or unscrewing, just snap on and use on sealed bearings, U-joints, high-pressure insert fittings and recessed fittings

Ready to use range is detailed in the following pages. Various other combinations, however can be devised based on specific application and need

The system is suitable for use with hand operated grease guns only



STEP 1
Retract sleeve of the quick connect system



STEP 2
Snap on the system by simply "Plugging On" the grease fitting to the coupler



STEP 3
Ensure that the quick connect system is secure



STEP 4
Release the sleeve of the quick connect system. The sleeve automatically slides over the coupler to encase it securely

To disconnect, simply reverse the operation

55

QUICK CONNECT ADAPTORS



FOR HAND OPERATED
GREASE GUN

DNN/1-8/90/Q



1,000 PSI
(69 BAR)



Quick Connect Right Angled Needle Nose Dispenser for dispensing a fine line of grease. The right angled design allows convenient access in shoulders & other confined areas

CAT. NR.

ORD. NR.

DNN/1-8/90/Q

44913

HC/14/4/90/Q



6,000 PSI
(413 BAR)



Quick Connect Right angled Grease Coupler Right angle coupler fitted onto the quick disconnect adaptor. For quickly converting regular couplers for greasing fittings with limited access, in low height areas etc. Fits straight onto the grease gun coupler

CAT. NR.

ORD. NR.

HC/14/4/90/Q

44912

GIN/01/Q



1,000 PSI
(69 BAR)



Quick Connect Grease Injector Needle useful for lubricating in very tight spaces such as sealed bearings, universal joints etc. Comes complete with protective plastic holder

CAT. NR.

ORD. NR.

GIN/01/Q

44914



RLA-01

Tip
1/4" (6.35 mm)
Body Diameter
0.31" (8 mm)



Professional Recessed Lube Adaptor for push on greasing of recessed fittings where obstructions would not permit the use of a regular hydraulic coupler

CAT. NR.	ORD. NR.
RLA/01	44921

ALA-01

Greasing End Diameter
0.19" (4.9 mm)



Professional 90° Angled Lube Adaptor for greasing inaccessible grease fittings in shoulders and other confined areas

CAT. NR.	ORD. NR.
ALA/01	44922

ANN/1-1-2

Tip
0.059" (1.5 mm)
Needle Diameter
0.156" (3.96 mm)



Professional Narrow Needle Nose Adaptor designed for greasing flush or hard to reach hydraulic type fittings in inaccessible areas

CAT. NR.	ORD. NR.
ANN/1-1-2	44920

ANN-4

Tip
0.046" (1.17 mm)
Needle Diameter
1/4" (6.35 mm)



Needle Nose Adaptor
Useful for dispensing a fine line of grease through the needle nose in greasing hard to reach fittings on trucks, vans, and recreational vehicles. Supplied with a small and a large locking sleeve to fit all couplers

CAT. NR.	ORD. NR.	THREADS
ANN/4	44905	1/8" NPT

AQD

Tip
0.046" (1.17 mm)
Needle Diameter
0.187" (4.76 mm)



Needle Nose Adaptor
Useful for dispensing a fine line of grease through the needle nose in greasing hard to reach fittings on trucks, vans, and recreational vehicles. Supplied with a small and a large locking sleeve to fit all couplers. Also available with Protective Shroud

CAT. NR.	ORD. NR.
AQD/11-16/B	44902
AQD/11-16/N	44903
AQD/11-16S/B WITH SHROUD	44904

HC/SW/3/Q



Professional 360° Swivel Coupler
Useful for effective lubrication of difficult & hard to reach grease fittings. Coupler swivels in full 360° circle & can be locked at intervals of 45°

CAT. NR.	ORD. NR.
HC/SW/3/Q	44911



FOR HAND OPERATED GREASE GUN

GBP/6/HC/14/4/Q



**6,000 PSI
(413 BAR)**

Coupler to Coupler Extension

6" (150 mm) angled delivery tube and 4 jaw professional coupler fitted onto the quick disconnect adaptor. Serves as an extra length extension on grease guns. Fits straight onto the grease gun coupler

CAT. NR.	ORD. NR.
GBP/6/HC/14/4/Q	44906

POC-1Q



**3,000 PSI
(207 BAR)**

Jaw Type Coupler to Button Head Coupler

Push on button head coupler fitted onto the quick disconnect adaptor. For quick conversion of jaw type couplers to button head coupler for use on 5/8" (16 mm) button head grease fittings directly. Fits straight onto the grease gun coupler

CAT. NR.	ORD. NR.
POC-1/Q	44907

HC/R/01/Q



**1,000 PSI
(69 BAR)**

Regular Coupler to Right Angled Coupler

Right angle coupler fitted onto the quick disconnect adaptor. For quickly converting regular couplers for greasing fittings with limited access, in low height areas etc. Fits straight onto the grease gun coupler

CAT. NR.	ORD. NR.
HC/R/01/Q	44908

SOD/01/Q



**1,000 PSI
(69 BAR)**

Jaw type Coupler to Seal Off Dispenser

Seal Off Dispenser fitted onto the quick disconnect adaptor. For quickly converting regular couplers for lubricating automobiles with grease plugs etc. Fits straight onto the grease gun coupler

CAT. NR.	ORD. NR.
SOD/01/Q	44909

GHC-12/SPR/W/ADP

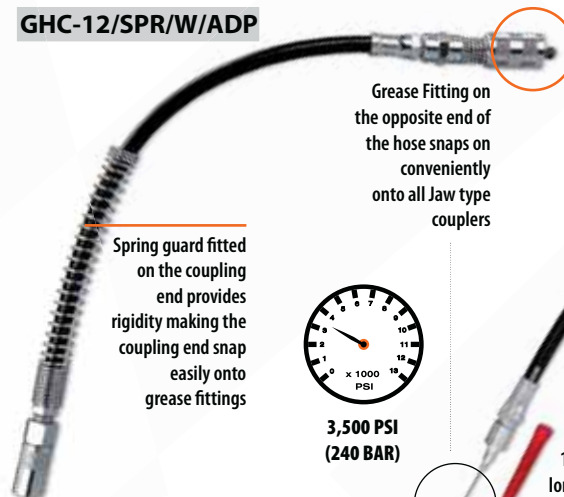

Spring guard fitted on the coupling end provides rigidity making the coupling end snap easily onto grease fittings



**3,500 PSI
(240 BAR)**

Quick Connect Hose

The Quick Connect Hose converts steel extension coupler assembly on grease guns to a flexible hose and allows the gun to be used for greasing hard to reach fittings. Overall length: 16" (410 mm)

CAT. NR.	ORD. NR.
GHC-12/SPR/W/ADP	44910

GHC/GIN/Q

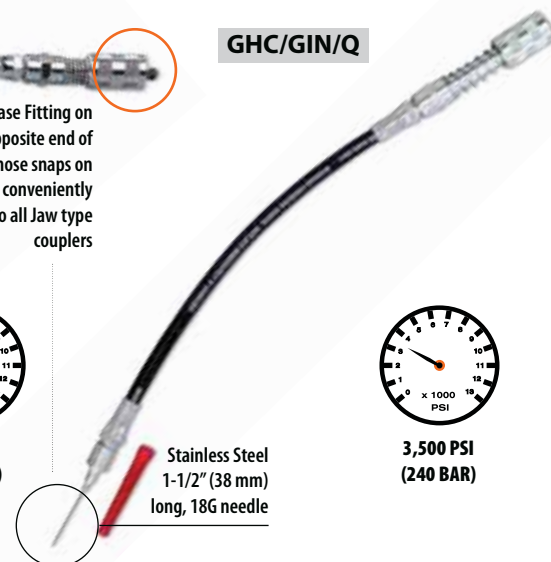

Grease Fitting on the opposite end of the hose snaps on conveniently onto all Jaw type couplers



**3,500 PSI
(240 BAR)**

Quick Connect Grease Hose & Needle

The Quick Connect Hose converts jaw type coupler on grease guns to a Grease Injector needle for greasing in very tight spaces such as universal joints & sealed bearings. Hose fitted onto the needle enables access onto hard to reach fittings as well as makes it easy to handle the needle without the risk of injury. Overall length: 15½" (393 mm)

CAT. NR.	ORD. NR.
GHC/GIN/Q	44875

56

QUICK DISCONNECT ADAPTOR



Adaptor with grease fitting on one end and male threads on the other

Threaded end can be screwed onto any dispenser with 1/8" female threads, thus allowing for quick connect greasing applications

Supplied with a small and large locking sleeve to fit most couplers

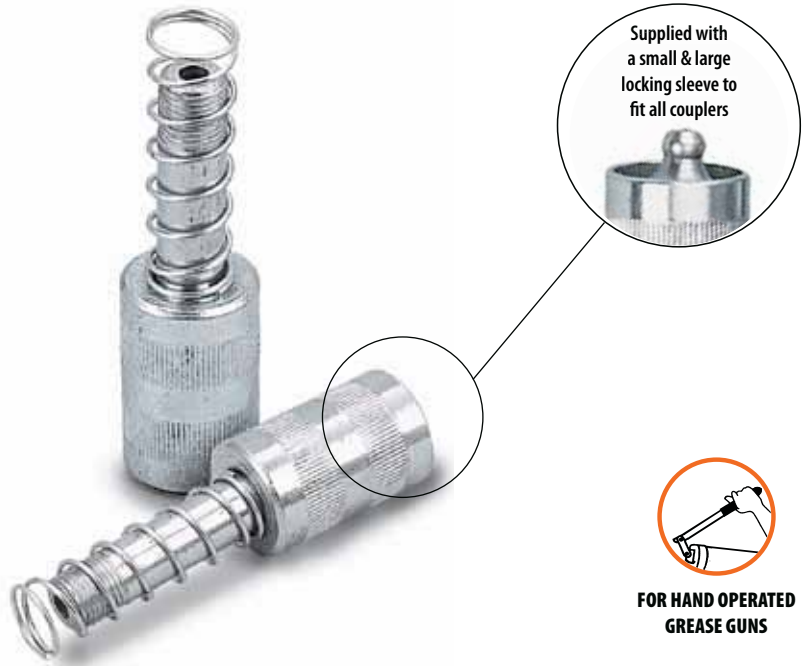

CAT. NR.	ORD. NR.	THREADS
AQD/11-16/UF/B	44900	1/8" BSPT
AQD/11-16/UF/N	44901	1/8" NPT

57

EZEE LUBE KIT

GAK-7



The Ezee-Lube kit comprises of a range of quick connect lube accessories. Useful for even the most difficult greasing jobs. The constituents convert any grease gun fitted with jaw type coupler into special application greasing. This helps in effective lubrication of grease plugs, sealed bearings, push on greasing of recessed fittings or fittings in shoulders, low height areas or an extension for reaching those "deep" places



CAT. NR.	ORD. NR.
* GAK/7	44950

Key * Best Seller

58

COMPOSITE AIR OPERATED GREASE RATIO PUMPS 50:1



INDUSTRIAL



AUTOMOTIVE

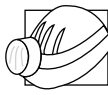

MINING

NEW!

GRP-03

GRP-04

GRP-08

Compact Air Operated 50:1 Grease Ratio Pump

Operates off most small compressors with size as small as 0.08 cubic meter / minute (3 cfm)

Ideal for applications having continuous need for high pressure grease in Industry, Workshops, Farm etc.

Zinc construction makes them suitable for mining applications

2.83" (72 mm) dia. air motor

Grease strainer at suction tube inlet, ensures clean grease to the bearing

Non corroding air motor design allows the pump to be used without an air line lubricator

Fitted with a pressure release valve- prevents both the pump & system against damage created by excessive pressure, possibly due to thermal expansion

Comes complete with drum cover, rubber lined follower plate, 7' (84") of high pressure grease hose, Z swivel & professional grease control valve

WETTED COMPONENTS

Zinc, hard chrome plated steel, brass, nitrile & polyurethane rubber

RECOMMENDED USE

With light and self collapsing grease up to NLGI No. 2

Control Valve threaded
1/4" (F) at inlet and
1/8" (F) at outlet



Z swivel threaded
1/4" NPT (M) x
1/4" NPT (F)



GRP/501-03

For use with 25-50 lbs / 20 kg / 5 gal. pails.
Suction tube length
17.5/16" (440 mm)

HOSE/GRP/84/N

44346

Available as spare:
84" high pressure hose
threaded 1/4" NPT (M)

SPECIFICATIONS

Working Pressure	4 – 10 BAR (60 to 150 PSI)
Maximum Air Pressure	10 BAR (150 PSI)
Maximum Outlet Pressure	500 BAR (7500 PSI)
Air Inlet Connection	1/4" NPT (F)
Pump Outlet Connection	1/4" NPT (F)
Air Consumption	270 lt / min (72 GPM)
Grease Output (NLGI No. 2 Grease)	0.460 kg / min (1 lb / min)
Noise Level	85 db

! WARNING

Pump must be supplied with clean & dry compressed air via an FR unit

CAT. NR.	ORD. NR.	FITS	DRUM COVER DIAMETER	FOLLOWER PLATE DIMENSIONS		
				O.D. STEEL END	O.D. PLATE	I.D. GROMMET
GRP/501/03	45400	25-50 lb / 20 kg / 5 gal. pails	12" (310 mm)	9.1/2" (241 mm)	11.11/32" (288 mm)	1.08" (27.5 mm)
GRP/501/04	45401	120 lb / 50 kg / 16gal pails	15" (381 mm)	12.11/16" (322 mm)	15" (380 mm)	1.08" (27.5 mm)
◆ GRP/501/08	45402	400 lbs / 180 kg / 55 gal pails	24-1/2" (622 mm)	21-5/8" (550 mm)	23-11/16" (602 mm)	1.08" (27.5 mm)

Key ◆ New



World-class Industrial High Pressure Grease pumps with guaranteed performance & hassle free operation

Pump dispenses Grease at pressures upto 50 times the Air inlet pressure

Designed to work in tough conditions - these are ideal for use in Industry, workshop, farm, construction or as part of the Mobile Grease system

All metal construction, fully CNC machined with hardened wear resistant moving parts

Reciprocating piston operated 2-1/2" (63 mm) dia. air motor

Fitted with strainer at suction tube inlet for clean grease to the bearing

Supplied complete with Drum Cover, rubber lined follower plate, 7' (84") of high pressure grease hose, Z swivel & professional grease control valve

Portable version available with built-in steel drum, complete with wheels & pull handle

WETTED COMPONENTS

Steel, Brass, Aluminium, Polyurethane & Nitrile Rubber

RECOMMENDED USE

With light and self collapsing grease up to NLGI No. 2

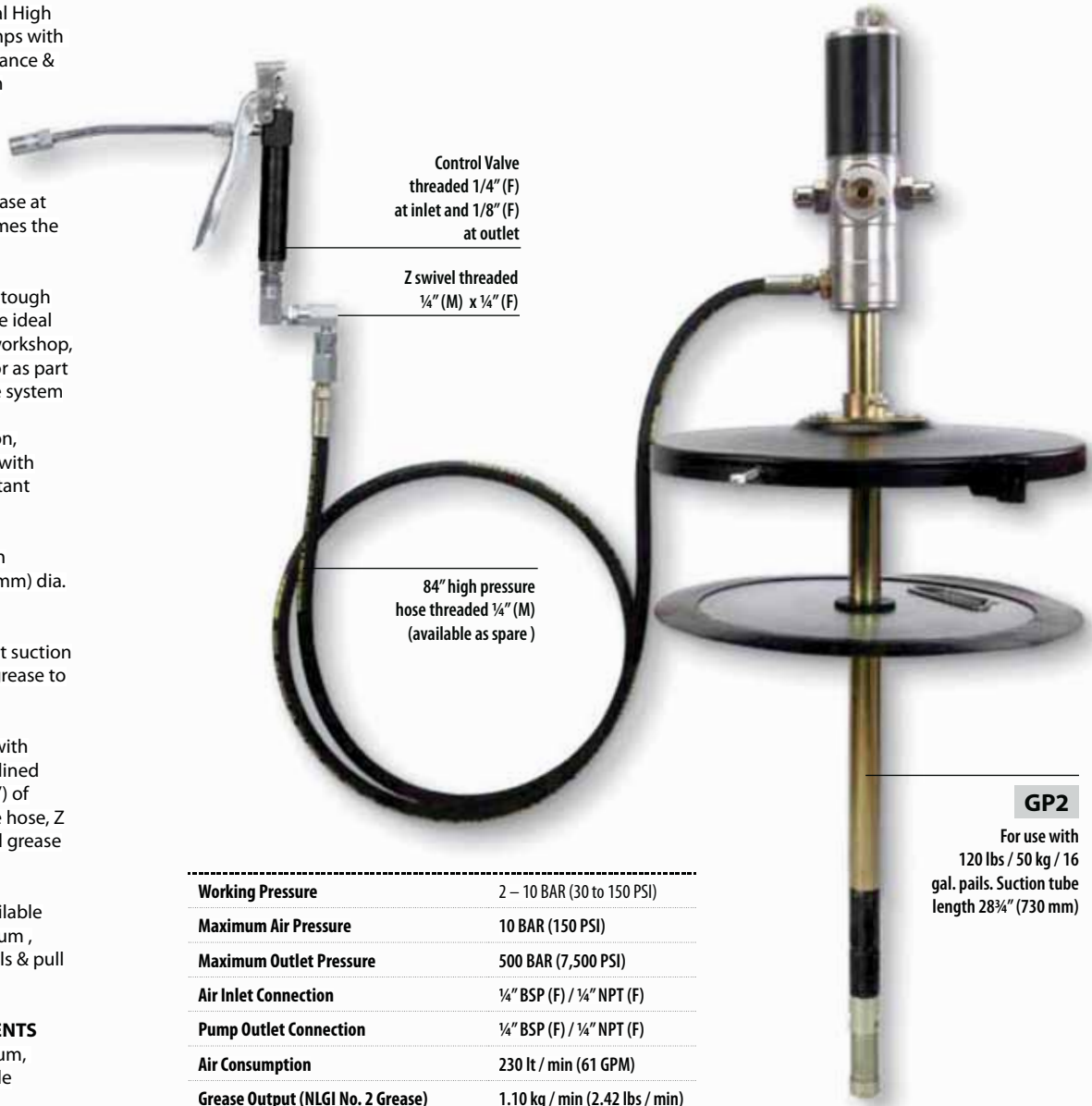

Working Pressure	2 – 10 BAR (30 to 150 PSI)
Maximum Air Pressure	10 BAR (150 PSI)
Maximum Outlet Pressure	500 BAR (7,500 PSI)
Air Inlet Connection	1/4" BSP (F) / 1/4" NPT (F)
Pump Outlet Connection	1/4" BSP (F) / 1/4" NPT (F)
Air Consumption	230 lt / min (61 GPM)
Grease Output (NLGI No. 2 Grease)	1.10 kg / min (2.42 lbs / min)
Noise Level	81 db

CAT. NR.	ORD. NR.	CAT. NR.	ORD. NR.	FITS	DRUM COVER DIAMETER	FOLLOWER PLATE DIMENSIONS		
						O.D. STEEL END	O.D. PLATE	I.D. GROMET
BSP THREADS		NPT THREADS						
◆ GP0/ST/501/BSP	45409	----	----	12.5 kg drums	11" (284 mm)	9-3/64" (230 mm)	10-1/8" (257 mm)	1.16" (29.5 mm)
GP1/ST/501/BSP	45410	GP1/ST/501/N	45415	25-50 lb / 5 gal. / 20-30 kg pails	12" (310 mm)	9-1/2" (241 mm)	11-11/32" (288 mm)	1.16" (29.5 mm)
GP2/ST/501/BSP	45411	* GP2/ST/501/N	45416	120 lb / 16 gal. / 50-60 kg pails	15" (381 mm)	12-11/16" (322 mm)	15" (380 mm)	1.16" (29.5 mm)
* GP3/ST/501/BSP	45412	GP3/ST/501/N	45417	400lb / 180 kg drums	24.1/2" (612 mm)	21-5/8" (550 mm)	23-11/16" (602 mm)	1.16" (29.5 mm)

NEW!

GP0

GP2

GP1

GP3

BGRP



GP0

For use with 12.5 kg pails. Suction tube length 17-5/16" (440 mm)

GP1

For use with 25-50 lbs / 20 kg / 5 gal. pails. Suction tube length 17-5/16" (440 mm)

GP3

For use with 400 lbs / 180 kg drums. Suction tube length 37-3/8" (950 mm)

BGRP/15

Portable Grease Pump with built-in 15 kg Grease Bucket

BGRP/30

Portable Grease Pump with built-in 30 kg Grease Bucket

BGRP/50

Portable Grease Pump with built-in 50 kg Grease Bucket



CAT. NR.	ORD. NR.	BUCKET CAPACITY
◆ BGRP/15	45432	15 kg
BGRP/30	45430	30 kg
BGRP/50	45431	50 kg

Key * Best Seller ◆ New

! WARNING

Pump must be supplied with clean & dry compressed air via an FRL unit

Premium quality Grease Control valve, for use with air operated grease pumps

Provides continuous grease flow, with trigger fully pressed

Steel construction, provides durability & longevity

Ergonomically designed pistol handle

Available as valve only, or fitted with 360° Z Swivel

Comes complete with 6" steel extension & heavy duty coupler

Available in a choice of inlet thread sizes

! WARNING

Skin Injection Hazard.
Keep away from nozzle

CAUTION
The gun is continuous action. Be careful not to over lubricate.



CAT. NR.	ORD. NR.	INLET THREAD SPECIFICATION	OUTLET THREAD SPECIFICATION
VALVE ONLY			
APG/04/1-8F/B	43400	1/8" BSPT (F)	1/8" BSPT (F)
* APG/04/1-4F/B	43401	1/4" BSPT (F)	1/8" BSPT (F)
APG/04/1-4F/M	43402	1/4" BSPT (F)	M10 x 1 (F)
APG/04/1-8F/N	43403	1/8" NPTF (F)	1/8" NPT (F)
* APG/04/1-4F/N	43404	1/4" NPTF (F)	1/8" NPT (F)
VALVE FITTED WITH Z SWIVEL			
+ * APG/04/Z/1-4F/B	43420	1/4" BSPT (F)	1/8" BSPT (F)
APG/04/Z/1-4M/B	43421	1/4" BSPT (M)	1/8" BSPT (F)
APG/04/Z/1-4F/M	43422	1/4" BSPT (F)	M10 x 1 (F)
+ * APG/04/Z/1-4F/N	43423	1/4" NPTF (F)	1/8" NPT (F)
APG/04/Z/1-2-27M/N	43424	1/2" -27 NS (M)	1/8" NPT (F)

Key

- * Best Seller
- + Standard on Groz GP Series Air Operated Grease Ratio Pumps



MAX. WORKING PRESSURE
7,500 PSI (517 BAR)

61

GREASE CONTROL VALVES -
BOOSTER

APG

APG-PR

Heavy Duty Grease control valve with built-in pressure boost mechanism. Provides continuous flow with pistol handle fully pressed

Pressure boost achieved through repeated actuation of the pistol handle. Boosts line pressure from 6,000 PSI (400 BAR) to 10,000 PSI (690 BAR); extremely useful to unblock frozen grease fittings

Heavy Duty steel construction, provides durability & longevity

Ergonomically designed pistol handle

Available as valve only, or fitted with 360° Z Swivel

Comes complete with 6" (150 mm) steel extension & coupler

Available in a choice of inlet thread sizes

! WARNING

Skin Injection Hazard.
Keep away from nozzle

CAUTION
The gun is continuous action. Be careful not to over lubricate.



MAX. WORKING PRESSURE
10,000 PSI (690 BAR)

APG

Booster Grease control valve. Complete with Heavy Duty 4 Jaw Coupler with ball check

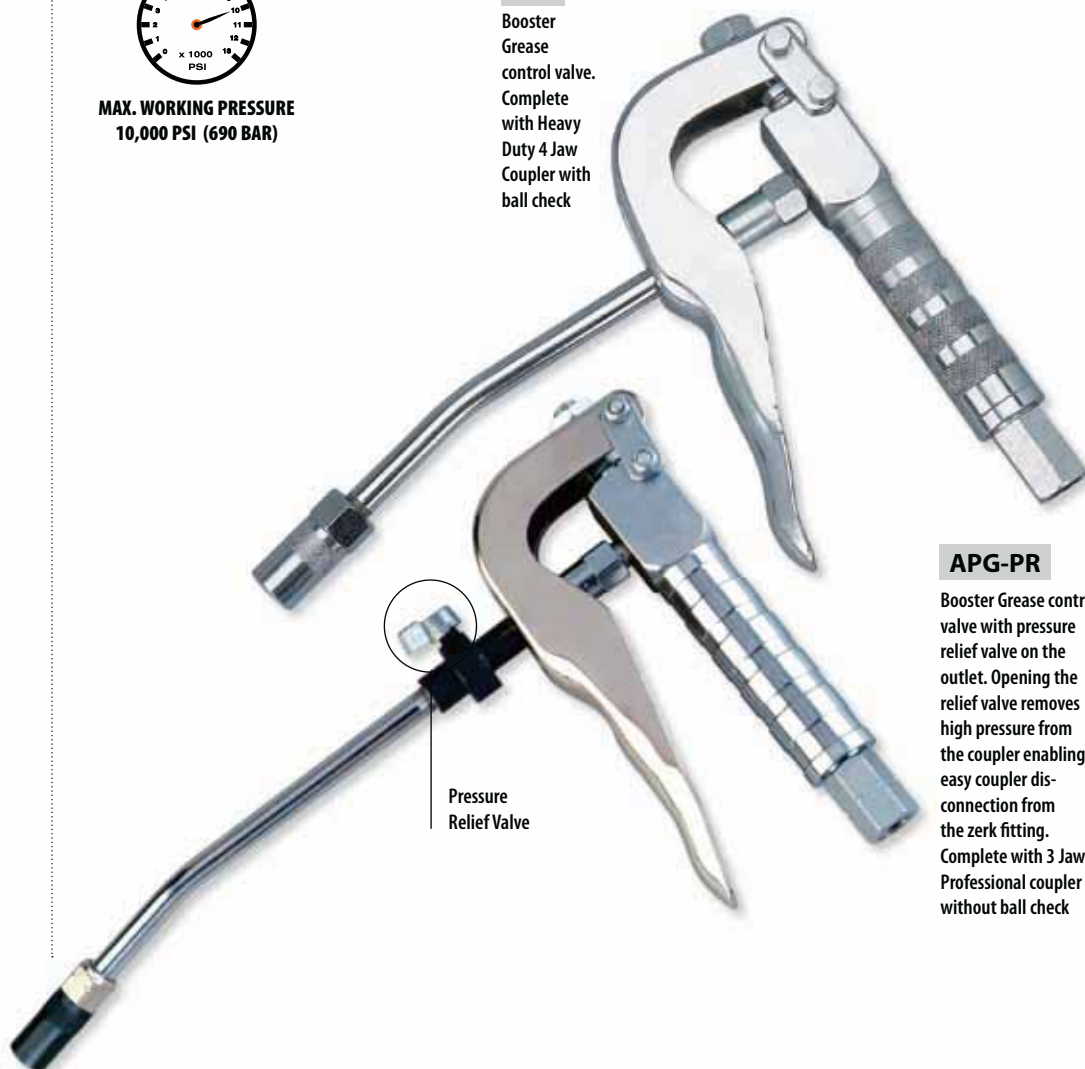
**APG-PR**

Booster Grease control valve with pressure relief valve on the outlet. Opening the relief valve removes high pressure from the coupler enabling easy coupler disconnection from the zerk fitting. Complete with 3 Jaw Professional coupler without ball check

Pressure Relief Valve

CAT. NR.	ORD. NR.	INLET THREAD SPECIFICATION	OUTLET THREAD SPECIFICATION
CONTROL HANDLE			
APG/1-8F/B	43450	1/8" BSPT (F)	1/8" BSPT (F)
* APG/1-4F/B	43451	1/4" BSPT (F)	1/8" BSPT (F)
APG/1-4F/M	43452	1/4" BSPT (F)	M10 x 1 (F)
APG/1-8F/N	43453	1/8" NPTF (F)	1/8" NPT (F)
* APG/1-4F/N	43454	1/4" NPTF (F)	1/8" NPT (F)
CONTROL HANDLE WITH Z-SWIVEL			
* APG/Z/1-4F/B	43470	1/4" BSPT (F)	1/8" BSPT (F)
APG/Z/1-4M/B	43471	1/4" BSPT (M)	1/8" BSPT (F)
* APG/Z/1-4F/M	43472	1/4" BSPT (F)	M10 x 1 (F)
APG/Z/1-4F/N	43473	1/4" NPTF (F)	1/8" NPT (F)
APG/Z/1-2-27M/N	43474	1/2"-27 NS (M)	1/8" NPT (F)

CAT. NR.	ORD. NR.	INLET THREAD SPECIFICATION	OUTLET THREAD SPECIFICATION
CONTROL HANDLE WITH PRESSURE RELIEF VALVE			
APG/PR/1-8F/B	43460	1/8" BSPT (F)	1/8" BSPT (F)
APG/PR/1-4F/B	43461	1/4" BSPT (F)	1/8" BSPT (F)
APG/PR/1-4F/M	43462	1/4" BSPT (F)	M10 x 1 (F)
APG/PR/1-8F/N	43463	1/8" NPTF (F)	1/8" NPT (F)
APG/PR/1-4F/N	43464	1/4" NPTF (F)	1/8" NPT (F)
CONTROL HANDLE WITH PRESSURE RELIEF VALVE & Z SWIVEL			
APG/PR/Z/1-4F/B	43465	1/4" BSPT (F)	1/8" BSPT (F)
APG/PR/Z/1-4M/B	43466	1/4" BSPT (M)	1/8" BSPT (F)
APG/PR/Z/1-4F/M	43467	1/4" BSPT (F)	M10 x 1 (F)
APG/PR/Z/1-4F/N	43468	1/4" NPTF (F)	1/8" NPT (F)
APG/PR/Z/1-2-27M/N	43469	1/2"-27 NS (M)	1/8" NPT (F)

Key * Best Seller

62

GREASE CONTROL VALVES METERED

NEW!

CE

Premium quality Grease Control valve, for use with air operated grease pumps

Built-In High Accuracy Digital Grease Meter for dispensing exact amount of grease

Ability to measure amount of grease dispensed prevents both over & under lubrication & is invaluable in saving bearing failures

Provides continuous grease flow, with trigger fully pressed

Steel construction, provides durability & longevity. Meter uses oval gear technology

Ergonomically designed pistol handle

Comes complete with 6" steel extension & heavy duty coupler



MAX. WORKING PRESSURE
7,500 PSI (517 BAR)

! WARNING

Skin Injection Hazard.
Keep away from nozzle

CAUTION
The gun is continuous action. Be careful not to over lubricate.

TEMPERATURE



Working Temperature Range
-10°C to 60°C (14°F to 140°F)

Oval gear mechanism

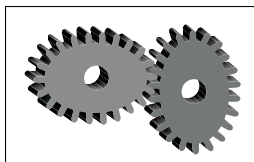

APG/04/1-4F/GM/B



DGM/2/N

Grease meter available as spare for in-line applications. Measures in both kg & lbs

SPECIFICATIONS

Control Valve Type	Continuous Flow
Meter Type	Digital Oval Gear
Grease Flow	0.1 to 2.5 kg / min (0.2 - 5.5 lb / min)
Max. Working Pressure	7,500 PSI (517 BAR)
Unit of Measurement	Kg / gms / oz. / lbs
Resolution	0.10 gms / 0.10 oz.
Accuracy	+/- 3%
Resettable Batch Total	9,999
Cumulative Total	999999
Battery Type	2 x 1.5V Size N

CAT. NR.	ORD. NR.	DESCRIPTION	THREAD SPECIFICATION
APG/04/1-4F/GM/B	43415	Meter Fitted to Grease Control Valve	Inlet: 1/4" BSPT (F)
APG/04/1-4F/GM/N	43416	Meter Fitted to Grease Control Valve	Inlet: 1/4" NPTF (F)
DGM/2/N	45621	In-Line Grease Meter	Inlet/Outlet: 1/8" NPT (F)

63

HIGH PRESSURE GREASE SWIVELS

HFC

HFC - R

HFC - S

Installed between the delivery hose & grease control valve, swivels permit easy handling of control valves and prevent damage to hose caused by twisting

Swivels have a heavy duty steel construction with ball bearings for smooth operation and free unrestricted movement

The swiveling joints are hardened for durability & wear resistance

Available in three forms: Straight, 90° & Z-360°, in varying thread specifications. Other thread sizes can be made on request

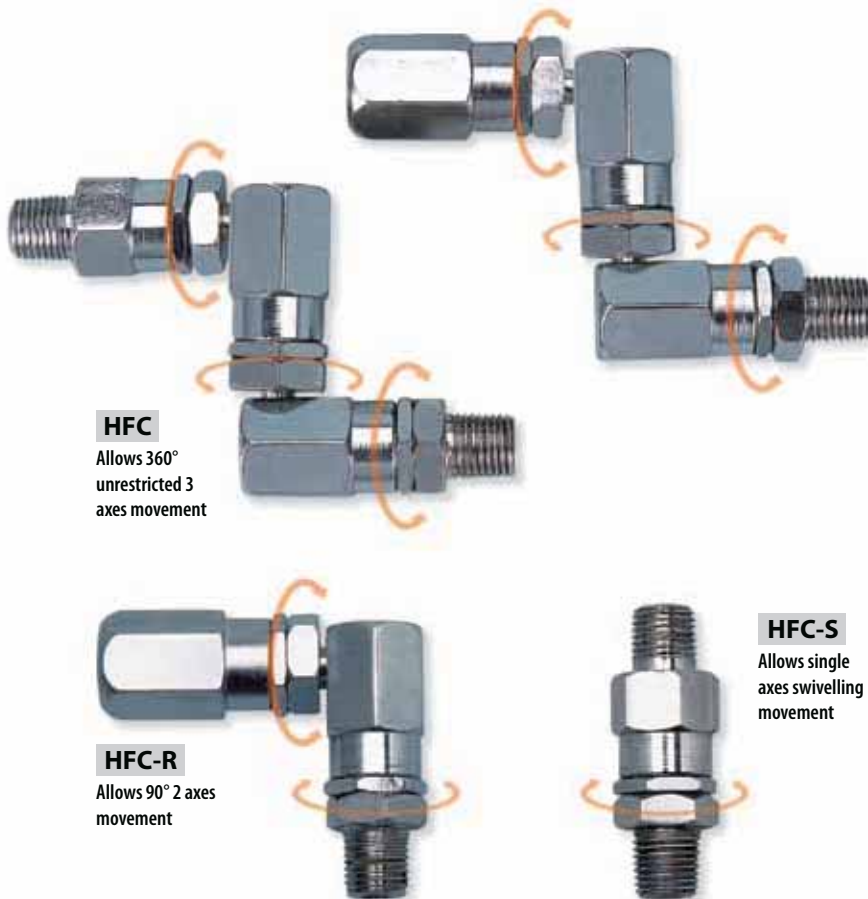

MAX. WORKING PRESSURE
6,000 PSI (413 BAR)

**HFC**

Allows 360°
unrestricted 3
axes movement

HFC-R

Allows 90° 2 axes
movement

HFC-S

Allows single
axes swivelling
movement

CAT. NR.	ORD. NR.	THREAD SPECIFICATION	
STRAIGHT SWIVELS			
HFC/S/1-4F/1-4M/B	43800	1/4" BSPT (F)	1/4" BSPT (M)
HFC/S/1-4F/1-8M/B	43801	1/4" BSPT (F)	1/8" BSPT (M)
HFC/S/1-8M/1-8M/N	43802	1/8" NPTF (M)	1/8" NPTF (M)
HFC/S/1-8F/1-8M/N	43803	1/8" NPTF (F)	1/8" NPTF (M)
HFC/S/1-4M/1-2-27M/N	43804	1/4" NPTF (M)	1/2" - 27 NS (M)
90° SWIVELS			
HFC/R/1-4F/1-4M/B	43810	1/4" BSPT (F)	1/4" BSPT (M)
HFC/R/1-4F/1-8M/B	43811	1/4" BSPT (F)	1/8" BSPT (M)
HFC/R/1-8M/1-8M/N	43812	1/8" NPTF (M)	1/8" NPTF (M)
HFC/R/1-8F/1-8M/N	43813	1/8" NPTF (F)	1/8" NPTF (M)
HFC/R/1-4M/1-2-27M/N	43814	1/4" NPTF (M)	1/2" - 27 NS (M)
Z - 360° SWIVELS			
HFC/1-4M/1-4M/B	43820	1/4" BSPT (M)	1/4" BSPT (M)
* HFC/1-4F/1-4M/B	43821	1/4" BSPT (F)	1/4" BSPT (M)
* HFC/1-4F/1-8M/B	43822	1/4" BSPT (F)	1/8" BSPT (M)
* HFC/1-4F/1-8M/N	43823	1/4" NPTF (F)	1/8" NPTF (M)
* HFC/1-4F/1-4M/N	43824	1/4" NPTF (F)	1/4" NPTF (M)
HFC/1-4M/1-2-27M/N	43825	1/4" NPTF (M)	1/2" - 27 NS (M)

Key * Best Seller

360° Z Swivel

Allows for convenient movement of the control valve & prevents the high pressure hose from kinking



64

FOOT OPERATED GREASE PUMP

NEW!

FOP-10

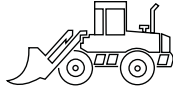

CONSTRUCTION



AUTOMOTIVE



AGRICULTURE



MINING

High Pressure Portable Grease Pump for quick effortless greasing in everyday lubrication such as greasing of excavators & other earth moving equipment, agricultural equipment, automotive etc.

Hands free operation

Pump operates using the Foot Lever, which greatly reduces effort & allows high pressure greasing with highest comfort

Can be operated by hand when under low machinery

Economical

Pump is operated by a single person & uses low cost bulk grease

Designed with all moving parts submerged in the same grease which needs to be pumped, thereby staying lubricated at all times

Moving parts create wave action in grease, auto removing air pockets & eliminating the use of a follower plate

Pump delivers 2 gms of grease per stroke & develops upto 8,700 PSI (600 BAR)

Works with NLGI 1 & 2 Greases

Lift handle

Steel Drum Cover

Steel Bucket with 10 kg (22 lbs.) capacity

Nozzle Holder

Pistol handle fitted with Steel Grease Extension & heavy duty coupler

Includes 2m x 1/4" ID high pressure rubber hose

Foot Lever

Rubber Pads



DELIVERS

Upto 2 gms / stroke
Upto 1 oz. / 15 strokes



8,700 PSI
(600 BAR)

CAT. NR.	ORD. NR.	BUCKET CAPACITY
◆ FOP/10A	44255	10 kgs (22 lbs.)

Key ◆ New

NOTE

Pump is 100% pressure tested using non food grade grease. New pumps would have some test grease inside, confirming that the pump has been factory tested



65

PORTABLE GREASING SYSTEM

GS-5

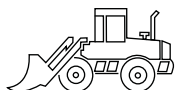

CONSTRUCTION



AUTOMOTIVE



AGRICULTURE

Fully Portable & single person operation manual greasing system designed for volume greasing in workshop environments, site applications, on a pick-up truck, tractor, earth moving equipment etc.

Pump is operated by foot press of the spring loaded system. The hose gets charged with grease, which can then be dispensed through the Super Gun fitted at the end of the hose. A single charge provides upto 30 shots of grease

Aluminium die cast super gun develops greasing pressure and has high pressure & high volume settings, actuated through a simple switch. High pressure setting dispenses 0.45 gm of grease in each shot at 10,000 PSI. High volume setting dispenses 1.25 gms per shot

High pressure feature is very useful to open blocked grease fittings

Pump assembly is fully sealed to prevent contamination

Pump comes complete with drum cover, rubber lined follower plate, premium 1/2" ID high pressure hose, Super gun fitted with steel extension & coupler and 11 lb. (5 kg.) plastic grease bucket

WETTED COMPONENTS

Aluminum, Steel, Brass, Polyurethane & Nitrile Rubber

RECOMMENDED USE

For Grease up to and including NLGI No. 2



DELIVERS

Upto 1.25 gm / stroke on high volume setting



10,000 PSI (690 BAR)

Common sight on construction equipment requiring high volume routine greasing



CAT. NR.	ORD. NR.	BUCKET CAPACITY	PUMP LENGTH BELOW DRUM COVER	DRUM COVER DIAMETER	FOLLOWER PLATE DIMENSIONS		HOSE LENGTH
					O.D. STEEL END	O.D. PLATE	
* GS/5	44250	5 kg / 11 lb.	7-3/4" (197 mm)	8-1/2" (216 mm)	6-3/4" (171 mm)	8-1/8" (206 mm)	1.5 m

Key * Best Seller

66

BUCKET GREASERS



Volume Grease Pump designed for quick effortless greasing in applications requiring everyday lubrication such as greasing of excavators & other earth moving equipment, agricultural equipment, automotive applications etc.

The Pump delivers upto 9 gms (0.30 oz.) of Grease per stroke which is twice the amount of grease discharge by any other pump. Fully CNC machined to very close tolerances, the pump develops pressure upto 4,000 PSI (275 BAR)

Whereas most pumps work only with light Greases, the VGP series pumps work equally well with NLGI 1 , 2 & 3 Greases

WETTED COMPONENTS
Steel, Aluminum, Brass & Nitrile Rubber

RECOMMENDED USE
For Grease up to and including NLGI 3



4,000 PSI (275 BAR)

high pressure setting

DELIVERS

Upto 9 gms / stroke (0.30 oz. / stroke)
high volume setting



VGP/10A

(Without wheel)
Capacity: 10 kgs / 22lbs.

VARIABLE HANDLE SETTING

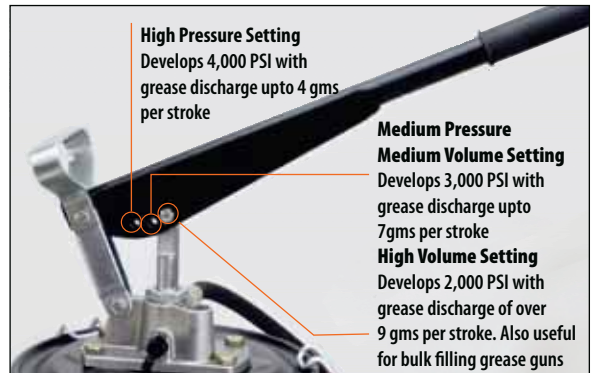

High Pressure Setting
Develops 4,000 PSI with grease discharge upto 4 gms per stroke

Medium Pressure Medium Volume Setting
Develops 3,000 PSI with grease discharge upto 7gms per stroke

High Volume Setting
Develops 2,000 PSI with grease discharge of over 9 gms per stroke. Also useful for bulk filling grease guns

CAT. NR.	ORD. NR.	CAT. NR.	ORD. NR.	BUCKET CAPACITY
WITHOUT WHEELS		WITH WHEELS		
VGP/6A	44280	VGP/6	44290	6 kg (13 lb.)
* VGP/10A	44281	VGP/10	44291	10 kg (22 lb.)
VGP/15A	44282	VGP/15	44292	15 kg (33 lb.)
---	---	◆ VGP/20	44293	20 kg (44 lb.)

Key * Best Seller ◆ New

VGP-6

VGP-10

VGP-15

VGP-20

NEW!



VGP/6A

(Without wheels)
Capacity : 6 kgs / 13lbs.



VGP/6

(With wheels)
Capacity : 6 kgs / 13lbs.



VGP/10

(With wheels)
Capacity : 10 kgs / 22lbs.



VGP/15A

(Without wheels)
Capacity : 15 kgs / 33lbs.



VGP/15

(With wheels)
Capacity : 15 kgs / 33lbs.

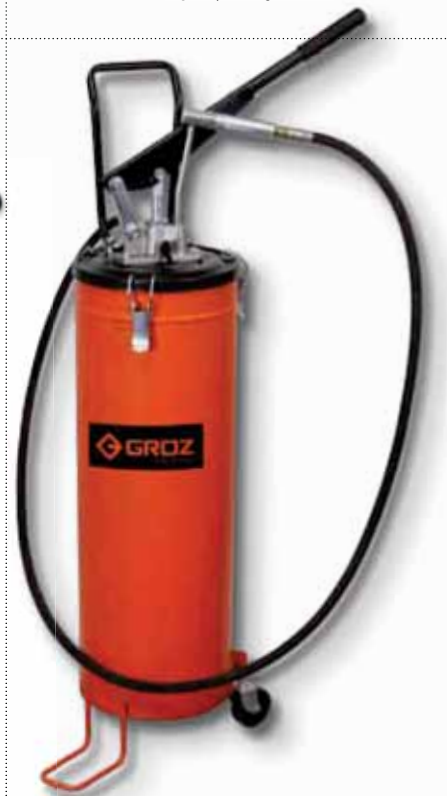

VGP/20

(With wheels)
Capacity : 20 kgs / 44lbs.

GREASE FILLER PUMP - PROFESSIONAL



Industry's # 1 bulk grease filling pump with extra heavy duty construction & discharge almost twice as much as any other filler pump

Ideal workshop complement combining economical bulk grease purchasing with the portability of a hand operated grease pump

Suitable for bulk filling grease guns, as well as transfer of grease from large to small containers

Solid cast aluminum pump head, ergonomic steel pump handle, solid steel drum cover with lift handle & rubber lined follower plate

Brass piston rings for minimal wear

Variable handle setting for increased convenience in use with light & heavy greases

Fully sealed to prevent contamination

RECOMMENDED USE

For grease up to and including NLGI 3

DELIVERS

54 gms (1.9 OZ.) / stroke

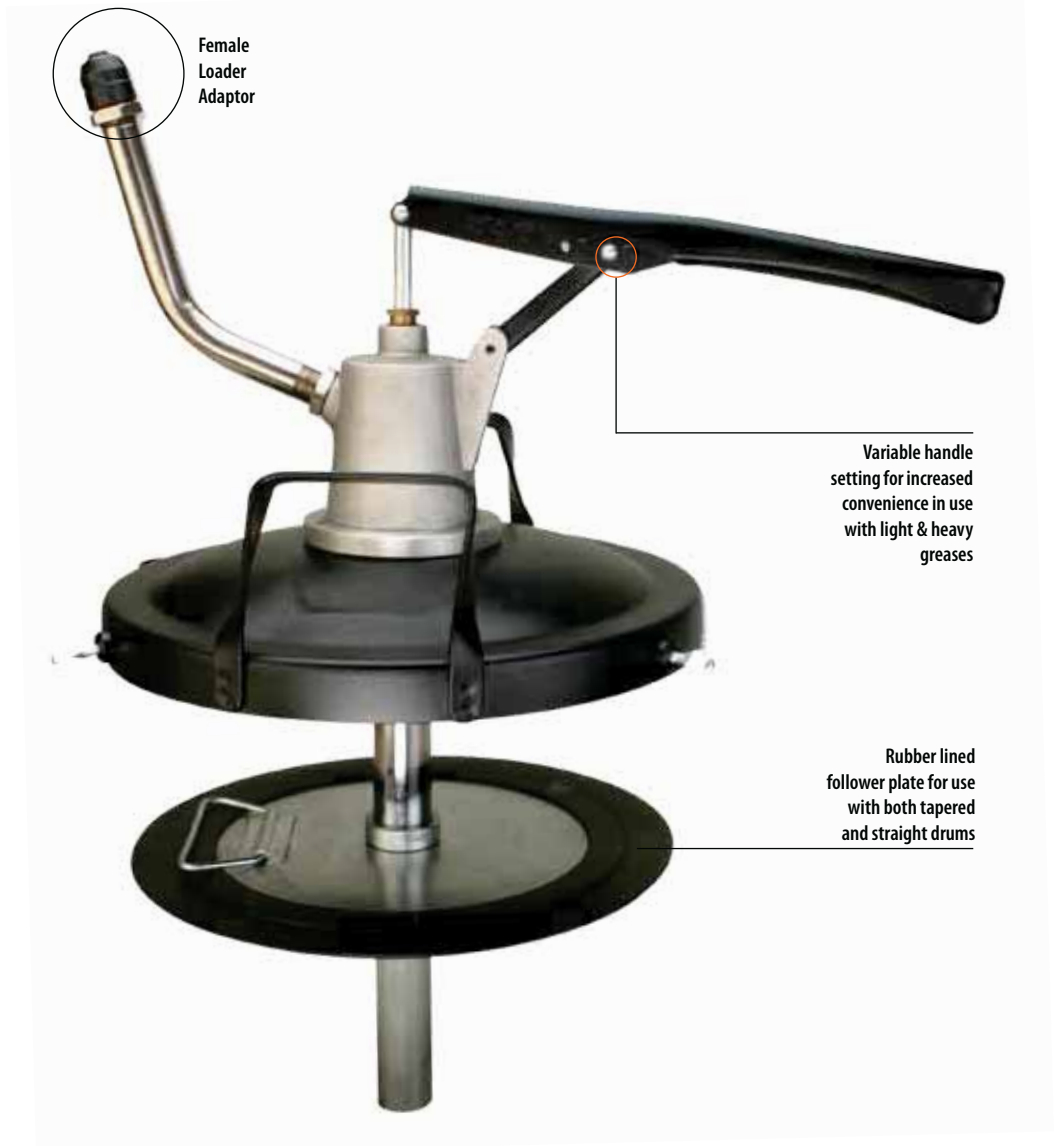

CAT. NR.	ORD. NR.	PAIL CAPACITY	PUMP LENGTH BELOW DRUM COVER	DRUM COVER DIAMETER	TYPE OF FOLLOWER PLATE	FOLLOWER PLATE DIMENSIONS			FEMALE LOADER ADAPTOR
						O.D. STEEL END	O.D. PLATE	I.D. PLATE	
J2-03/BL/B	44216	20 kg	12" (310)	12" (310)	Rubber Lining	9-3/8" (238 mm)	11-1/2" (293 mm)	1-1/4" (31.4 mm)	Suitable for 9 mm straight loader fittings
J2-03/BL/N	44215	5 gal. (20-50 lbs)	12" (310)	12" (310)	Rubber Lining	9-3/8" (238 mm)	11-1/2" (293 mm)	1-1/4" (31.4 mm)	Suitable for 0.58" American tapered loader fittings

68

GREASE FILLER PUMPS



INDUSTRIAL



AUTOMOTIVE



AGRICULTURE

GPP-02

GFP-03

GFP-04

Easy to use Grease filling solution to load bulk or combination grease guns from bulk grease pails

No mess or waste. Full economy in buying bulk grease

Complete unit includes zinc plated pump with zinc die cast pump head and cast aluminum adjusting flange, drum cover, follower plate & female loader fitting

Select models include follower plate with rubber lining for use with tapered drums

Available with a choice of Female loader adaptors:
Regular for use with American Tapered 0.58" (14.7 mm) male loader fittings or Universal which adapts to both European Straight (9 mm) and American Tapered 0.58" (14.7 mm) male loader fittings

RECOMMENDED USE

For Light & self Collapsing Grease up to and including NLGI 2



GFP-03-PRO/UNI



GFP-03

For use with 25-50 lb. / 5 gal. American grease pails

DELIVERS

Upto 28 gms (1 oz.) / stroke



USEFUL TIPS!

Prime pump when using for the first time. Pour 30 ml. oil in to the pump outlet & operate lever handle till grease starts dispensing. Never exert undue pressure on the lever handle

CAT. NR.	ORD. NR.	PAIL CAPACITY	PUMP LENGTH	DRUM COVER DIAMETER	TYPE OF FOLLOWER PLATE	FOLLOWER PLATE DIMENSIONS			FEMALE LOADER ADAPTOR
						O.D. STEEL END	O.D. PLATE	I.D. GROMMET	
GFP/02-PRO/UNI	44200	12.5 kg	18" (457 mm)	287 mm	Rubber Lining	230 mm	272 mm	38 mm	Universal
GFP/03	44210	25-50 lb / 5gal.	18" (457 mm)	12" (310 mm)	Steel	-	11" (280 mm)	1.1/2" (38 mm)	American
GFP/03-PRO	44211	25-50 lb / 5gal. / 20 kg	18" (457 mm)	12" (310 mm)	Rubber Lining	9.1/2" (241 mm)	11-11/32" (288 mm)	1.1/2" (38 mm)	American
* GFP/03-PRO/UNI	44212	25-50 lb / 5gal. / 20 kg	18" (457 mm)	12" (310 mm)	Rubber Lining	9.1/2" (241 mm)	11-11/32" (288 mm)	1.1/2" (38 mm)	Universal
GFP/04	44222	120 lb. / 50 kg	30" (760 mm)	15" (381 mm)	Steel	-	13-5/8" (346 mm)	1.1/2" (38 mm)	American
GFP/04-PRO	44220	120lb. / 50 kg	30" (760 mm)	15" (381 mm)	Rubber Lining	12-11/16" (322 mm)	15" (380 mm)	1.1/2" (38 mm)	American
GFP/04-PRO/UNI	44221	120lb. / 50 kg	30" (760 mm)	15" (381 mm)	Rubber Lining	12.11/16" (322 mm)	15" (380 mm)	1.1/2" (38 mm)	Universal

Key * Best Seller

69

HIGH PRESSURE GREASE PUMPS

GFP-HP

HPG-10



INDUSTRIAL



AUTOMOTIVE



AGRICULTURE



CONSTRUCTION

An easy & portable high pressure hand operated grease pump

Provides high pressure greasing, where power is not available or when an air operated grease pump cannot be afforded

Useful for clean greasing of machinery, equipment, trucks & cars

Pump has steel construction with aluminum cast head & solid steel pumping chamber

Comes complete with Lift handle, Drum Cover, Rubber Lining Follower plate, 48" (1220 mm) flexible grease hose fitted with professional 4 jaw coupler. Model HPG-10 additionally includes a 10 kg (22 lb.) steel Grease Bucket



Lift Handle

GHC-48/HC/14/4/B

44345

48" flexible high pressure hose with coupler (available as spare)



USEFUL TIPS!

Prime pump when using for the first time. Pour 30 ml. oil in to the pump outlet & operate lever handle till grease starts dispensing.

GFP/HP-03/PRO

For use with 25-50 lb/20 kg. grease pails



GFP/HP-02/PRO

For use with 12.5 kg Grease Buckets popular in the United Kingdom



HPG-10

Includes 10kg (22 lb.) steel Grease Bucket with foot rest

DELIVERS

1.5 gms / stroke
(1 oz. in 19 strokes)



3,500 PSI
(240 BAR)

CAT. NR.	ORD. NR.	PAIL CAPACITY	PUMP LENGTH BELOW DRUM COVER	DRUM COVER DIAMETER	TYPE OF FOLLOWER PLATE	FOLLOWER PLATE DIMENSIONS		
						O.D. STEEL END	O.D. PLATE	I.D. GROMMET
* GFP/HP-02/PRO	44231	12.5 kg	315 mm	287 mm	Rubber Lining	230 mm	272 mm	25 mm
GFP/HP-03/PRO	44230	25-50 lb / 20 kg	13.11/16" (348 mm)	12" (310 mm)	Rubber Lining	9.1/2"	11.11/32"	1"
HPG/10	44245	10 kg	367 mm	224 mm	Rubber Lining	195 mm	225 mm	25 mm

Key * Best Seller

70

FOLLOWER PLATES

A range of follower plates, for use with Grease pumps

Follower plates eliminate channeling & air pockets, keep lubricants from contamination & assist in pumping all of the lubricant from containers

FP/01**All Steel Follower Plates**

These are made out of plated sheet metal. The rubber grommet fitted on the centre of the follower plate is slid on the pump suction tube. Used commonly as a low cost alternative with straight grease pails

**FLP/241/288****Rubber Lining Follower Plates**

These have a metal main body, with a grease resistant rubber lining. The rubber lining is very effective in wiping grease from container walls and eliminating any air pockets. A steel handle is welded onto the plate for easy removal of the plate, after the grease container is emptied. The rubber grommet fitted on the centre of the follower plate is slid on the pump suction tube. Useful for both straight & tapered grease pails

**FLP/241-288/1**

CAT. NR.	ORD. NR.	PAIL CAPACITY	OUTER DIA. OF RIGID STEEL END OF FOLLOWER PLATE	OUTER DIA. OF FOLLOWER PLATE	INNER DIA. OF GROMMET RUBBER	FOR USE WITH GROZ PUMP SERIES
ALL STEEL FOLLOWER PLATES						
FP/01	44320	25-50 lb / 5gal.	11" (280 mm)	11" (280 mm)	1.1/2" (38 mm)	GPF/03
FLP/346	44329	120 lb / 16 gal. / 50 kg	13-5/8" (346 mm)	13-5/8" (346 mm)	1.1/2" (38 mm)	GPF/04
RUBBER LINING FOLLOWER PLATES						
FLP/195-225/6	47820	15 kg	195 mm	225 mm	29 mm	BGRP/15
FLP/230-272	44321	12.5 kg	230 mm	272 mm	38 mm	GFP/02
FLP/230-272/1	44334	12.5 kg	230 mm	272 mm	25 mm	GFP/HP-02
FLP/230-272/6	47821	12.5 kg	230 mm	272 mm	1.16" (29.5 mm)	GP0
FLP/241-288	44322	25-50 lb / 5gal. / 20 kg	9-1/2" (241 mm)	11-11/32" (288 mm)	1-1/2" (38 mm)	GFP/03
FLP/241-288/1	44323	25-50 lb / 5gal. / 20 kg	9-1/2" (241 mm)	11-11/32" (288 mm)	1" (25 mm)	GFP/HP-03
FLP/241-288/2	44324	25-50 lb / 5gal. / 20 kg	9-1/2" (241 mm)	11-11/32" (288 mm)	1.08" (27.5 mm)	GRP/501/03
FLP/241-288/3	47822	25-50 lb / 5gal. / 20 kg	9-1/2" (241 mm)	11-11/32" (288 mm)	1-7/32" (31.3mm)	-
FLP/241-288/4	47823	25-50 lb / 5gal. / 20 kg	9-1/2" (241 mm)	11-11/32" (288 mm)	1-13/32" (36mm)	-
FLP/241-288/6	44330	25-50 lb / 5gal. / 20 kg	9-1/2" (241 mm)	11-11/32" (288 mm)	1.16" (29.5 mm)	GP1, BGRP/30
FLP/241-288/7	47824	25-50 lb / 5gal. / 20 kg	9-1/2" (241 mm)	11-11/32" (288 mm)	1-9/16" (40mm)	-
FLP/322-380	44325	120lb. / 16 gal. / 50 kg	12.11/16" (322 mm)	15" (380 mm)	1.1/2" (38 mm)	GFP/04
FLP/322-380/1	47825	120lb. / 16 gal. / 50 kg	12.11/16" (322 mm)	15" (380 mm)	1" (25 mm)	-
FLP/322-380/2	44326	120lb. / 16 gal. / 50 kg	12.11/16" (322 mm)	15" (380 mm)	1.08" (27.5 mm)	GRP/501/04
FLP/322-380/3	47826	120lb. / 16 gal. / 50 kg	12.11/16" (322 mm)	15" (380 mm)	1-7/32" (31.3mm)	-
FLP/322-380/6	44331	120lb. / 16 gal. / 50 kg	12.11/16" (322 mm)	15" (380 mm)	1.16" (29.5 mm)	GP2, BGRP/50
FLP/550-602/6/GP3	44333	400 lb / 180 kg	21-5/8" (550 mm)	23-11/16" (602 mm)	1.16" (29.5 mm)	GP3

Caution: Above recommendations may not work with all containers of similar capacity. Due to difference in lube container specifications from one company to another, there can be a difference in your container size. Above recommendations are based on most widely used container specifications worldwide. Pls. ensure that your lube container falls within the above specified follower plate dimensions, for using standard parts. Other follower plate sizes can be made on request.

71

FEMALE LOADER ADAPTORS

Female adaptors are mounted on Grease Filler pumps for bulk filling Grease Guns

Male Loader fitting on Grease Gun fits onto the female loader adaptor with the rubber seal in the adapter making the transfer leak-proof

Adaptors are threaded 1/4" NPT (F)



ADP-9147

Universal Bulk Loader Valve

This dual-purpose adaptor can be used with both 9 mm Straight & American Tapered 0.58" (14.7 mm) Bulk Loader Valves

The top sleeve adapts to 9mm straight loader valves, which may be removed, and the base used with the larger 0.58" (14.7 mm) loader fittings



SFA/1-4/N

Adaptor for American Bulk Loader Valves only. These are designed for use with American Tapered 0.58" (14.7 mm) Bulk Loader Valves



Female Loader Adaptor mounted on Grease Filler Pump

CAT. NR.	ORD. NR.	TYPE
SFA/1-4/N	44360	For American Tapered 0.58" (14.7 mm) loader valves
ADP/9147	44361	Universal Adaptor for use with both 9 mm Straight & tapered 0.58" (14.7 mm) loader valves

OILING equipment

New pumps & Dispensers
carefully designed to
guarantee **NO DOWNTIME** in
your plant & machinery

NEW PRODUCTS to look out for

78 LEVER ACTION BARREL PUMP - CLEAR TUBE

90 EZEE FLO PUMP

96 AIR OPERATED STAINLESS STEEL PUMP

98 AIR OPERATED DOUBLE DIAPHRAGM PUMPS

102 ELECTRIC OIL METERS

103 MECHANICAL OIL METERS

104 ELECTRIC OIL CONTROL GUNS

105 MECHANICAL OIL CONTROL GUNS

107 ELECTRONIC PRESET OIL CONTROL GUN

110 SUCTION GUNS - CLEAR TUBE

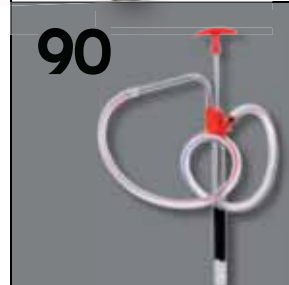

72

LEVER ACTION BARREL PUMPS



AUTOMOTIVE



INDUSTRIAL



CONSTRUCTION



RAILWAY

NEW!

LBP-04

LBP-04-CL

LBP-06

LBP-96

Most popular pump design, engineered for professional use

Premium powder coated steel pump body with ribbed section aluminum die cast pump head for maximum strength

Built-in 1.1/2" & 2" bung for use on drums with either openings

Plated steel lever handle with rubber grip for convenience

Wear resistant brass piston rings fitted onto zinc die cast piston

Comes complete with curved metal spout & telescopic suction tube for use on 15 gallon (50 litres) – 55 gallons (205 litre) barrels

WETTED COMPONENTS
Steel, Aluminum, Zinc, Brass, NBR & Viton*
*not on LBP-04

Note:
Clear tube pump uses rubber piston rings fitted onto steel piston



LBP-04

Oil Pump for use with oil based fluids, heating oils, motor oils, heavy & light oils, Diesel & Kerosene. Non return seal is NBR rubber. Pump is not suited for use with water based fluids, solvents, acids, antifreeze, gasoline etc.



Also available with Clear Tube Barrel



LBP-04-CL

Clear Barrel provides quick lubricant identification eliminating the risk of mixing incompatible or unspecified lubricants

Visibility to remaining oil as well as lubricant contamination in the barrel is also possible

DELIVERS



Upto 300 ml (10 oz. / stroke)

CAT. NR.	ORD. NR.
LEVER ACTION BARREL PUMP	
* LBP/04	44100
LEVER ACTION BARREL PUMP - CLEAR TUBE	
◆ LBP/04-CL	46950
ANTIFREEZE BARREL PUMP	
LBP/06	44120
ANTIFREEZE BARREL PUMP WITH NON DRIP	
LBP/96	44125

Key * Best Seller ◆ New



LBP-06

Antifreeze Barrel pump for use with Antifreeze, thinners, automotive additives, industrial chemicals, oil based fluids & other non corrosive liquids. Non return seal is Viton rubber. Pump is not suited for use with water based fluids, corrosive media, gasoline etc.



LBP-96

Basic pump is same as the LBP-06, except that the outlet discharge spout has a built-in aluminum die cast non drip attachment. Additionally outlet spout has a welded steel holder which performs a dual role -
a) cover preventing any contaminants to enter inside the pump;
b) holder for hanging buckets / containers for easy filling of media

73

LEVER ACTION OIL PUMP

EBP-02



AUTOMOTIVE



WORKSHOP



Ideal for dispensing oil from drums

Value Engineered for optimal performance at an affordable cost

Built-in 1.1/2" & 2" bung for use on drums with either openings

Nitrile Rubber piston rings for smooth operation

Comes complete with curved metal spout & telescopic plastic suction tube for use on 15 gallon (50 litres) to 55 gallons (205 litre) barrels

WETTED COMPONENTS

Steel, Aluminum, PVC & NBR

RECOMMENDED USE

Oil based fluids, heating oils, motor oils, heavy & light oils, Diesel & Kerosene

DO NOT USE WITH

Water based fluids, solvents, acids, antifreeze, gasoline etc.

DELIVERS



Upto 300 ml (10 oz. / stroke)

CAT. NR.	ORD. NR.
EBP/02	44116

OILING EQUIPMENT

74

VERTICAL LIFT PUMP

VLP



AUTOMOTIVE



WORKSHOP



Self priming Hi volume Vertical Lift Pump for use with petroleum based media

Steel construction with Aluminum die cast head, steel plunger rod & PTFE seals

Piston is made from zinc with wear resistant brass piston rings

Complete with 2" cast iron bung adaptor

WETTED COMPONENTS

Steel, Aluminum, Zinc, Brass & PTFE

RECOMMENDED USE

High viscosity petroleum based media, lacquer thinners etc.

DO NOT USE

With Gasoline, water based & other corrosive media

DELIVERS



Upto 750 ml (26 oz. / stroke)

CAT. NR.	ORD. NR.	FOR USE ON
VLP/01	44130	55 gal. (205 litre) drums

75

FRONT ACTION BARREL PUMP

A2



INDUSTRIAL



AUTOMOTIVE



WORKSHOP

Unique front action operation

Makes pumping easy & allows the pump to be used on barrels placed in corners & other inaccessible areas

Heavy Duty Aluminum Die Cast Pump head incorporates 2" bung threads

Brass Piston rings for increased life

No riveted parts, allows 100% serviceability

"Built-in" nozzle holder for convenient storage of discharge hose

Includes 1.8m PVC Nitrile delivery hose with metal nozzle, spring & hose clamp

Comes complete with telescopic suction tube for use on 15 gallons (50 litre) – 55 gallons (205 litre) drums

WETTED COMPONENTS
Steel, Aluminum, Brass, NBR and PVC Nitrile

RECOMMENDED USE
For dispensing Diesel, Kerosene, Heating Oils, Motor Oils, Lubricating Oils (upto SAE 90), and other non-corrosive media

DO NOT USE
With water based media, Antifreeze, Solvents, Acids, and Gasoline etc.

NOTE
Pump variations available without hose / with Viton seals for use with Antifreeze & other reactive media



CAT. NR.	ORD. NR.
A2H/BL	44110

DELIVERS 
Upto 250 ml (9 oz. / stroke)

76

QUART / LITRE STROKE PUMP

QSP



INDUSTRIAL



AUTOMOTIVE



WORKSHOP

OILING EQUIPMENT

Heavy duty Industrial Pump that dispenses 1 Quart / 1 Litre per stroke

An economical way to dispense exact quantity of media per stroke

Extremely useful in applications requiring metered delivery, the pump works on a precision rack & pinion mechanism

Pump has a built in 2" Bung Adaptor & comes complete with a telescopic suction tube for use with 15 gallons (50 litre) – 55 gallons (205 litre) barrels

Other design features include:

- a. Spring Loaded Drain Back Tube for overflowed media
- b. Lockable handle which allows the pump to be pad locked, when not in use
- c. Lock Nut for positioning the pump outlet in any direction

WETTED COMPONENTS

Steel, Aluminum, Nitrile Rubber & Acetal

RECOMMENDED USE

Gear & Lube Oil, Petroleum based Media, Diesel & Kerosene

DO NOT USE WITH

Water Based & other corrosive fluids

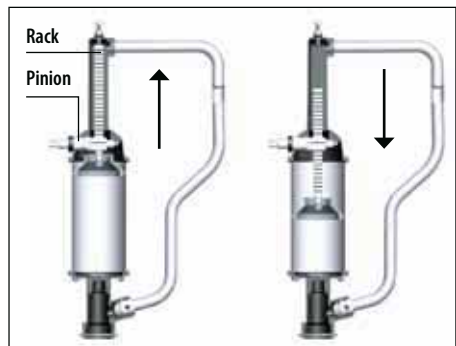
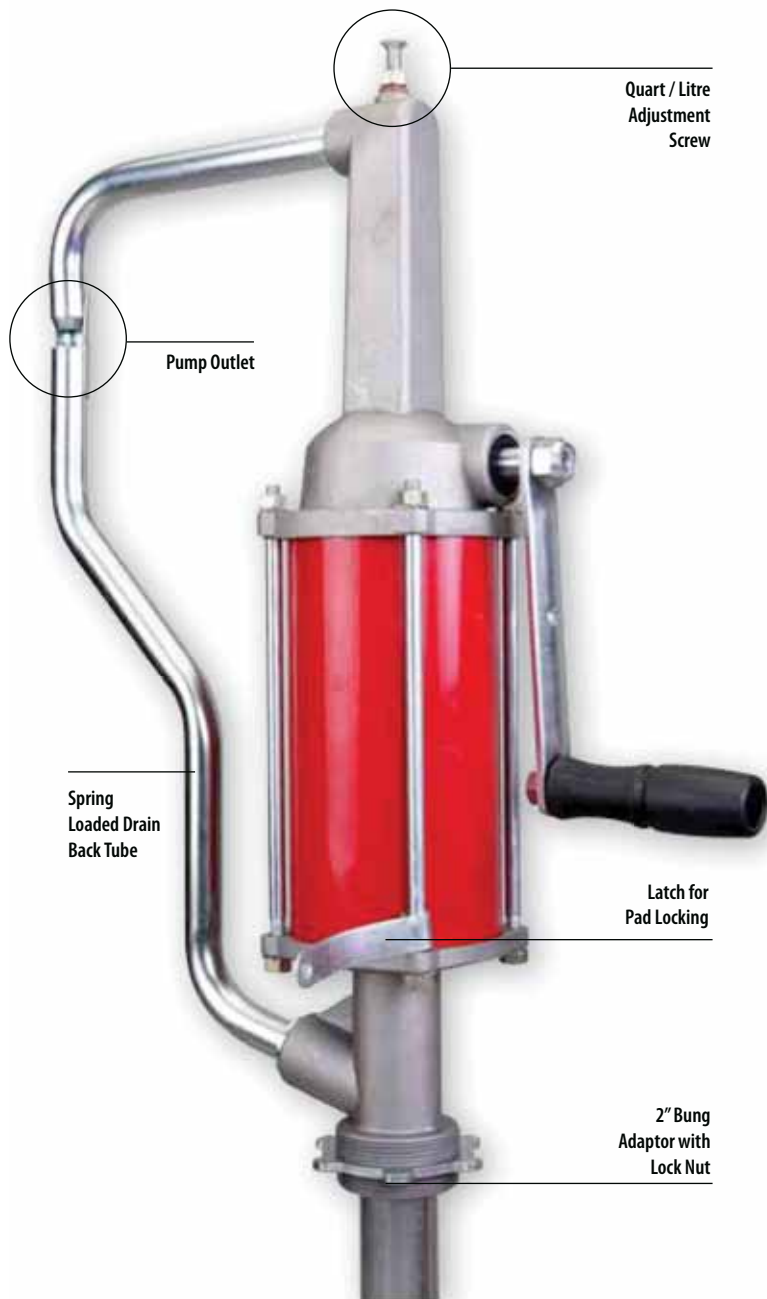

CAT. NR.	ORD. NR.
QSP/01	44187

DELIVERS 
1 litre (1 quart) / stroke

77

ROTARY BARREL PUMPS

GNB-20

GNB-25



AGRICULTURE

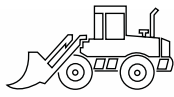

CONSTRUCTION



AUTOMOTIVE



WORKSHOP

Most popularly used pump worldwide. The Groz version of the Rotary Pump is superior to any other with features such as Dual Directional Operation which allows the pump to both empty, as well as refill containers

Extremely heavy duty & rugged weighing 6.6 kgs (14.5 lbs)

Pump body is sturdy cast iron with precisely machined cast iron vanes for better draw & smoother delivery

Fits 15 gallons (50 litre) to 55 gallons (205 litre) barrels

Comes complete with suction tube, 2" cast iron bung nut & discharge spout

WETTED COMPONENTS

Steel, Cast Iron, NBR / Viton

RECOMMENDED USE

For dispensing Diesel, Kerosene, Heating Oils, Motor Oils, Lubricating Oils (upto SAE 90), and other non-corrosive media

DO NOT USE

With water based media, Antifreeze, Solvents, Acids, Gasoline etc.

Dual Directional Operation: Pumps in either direction by a few reverse turns of the handle

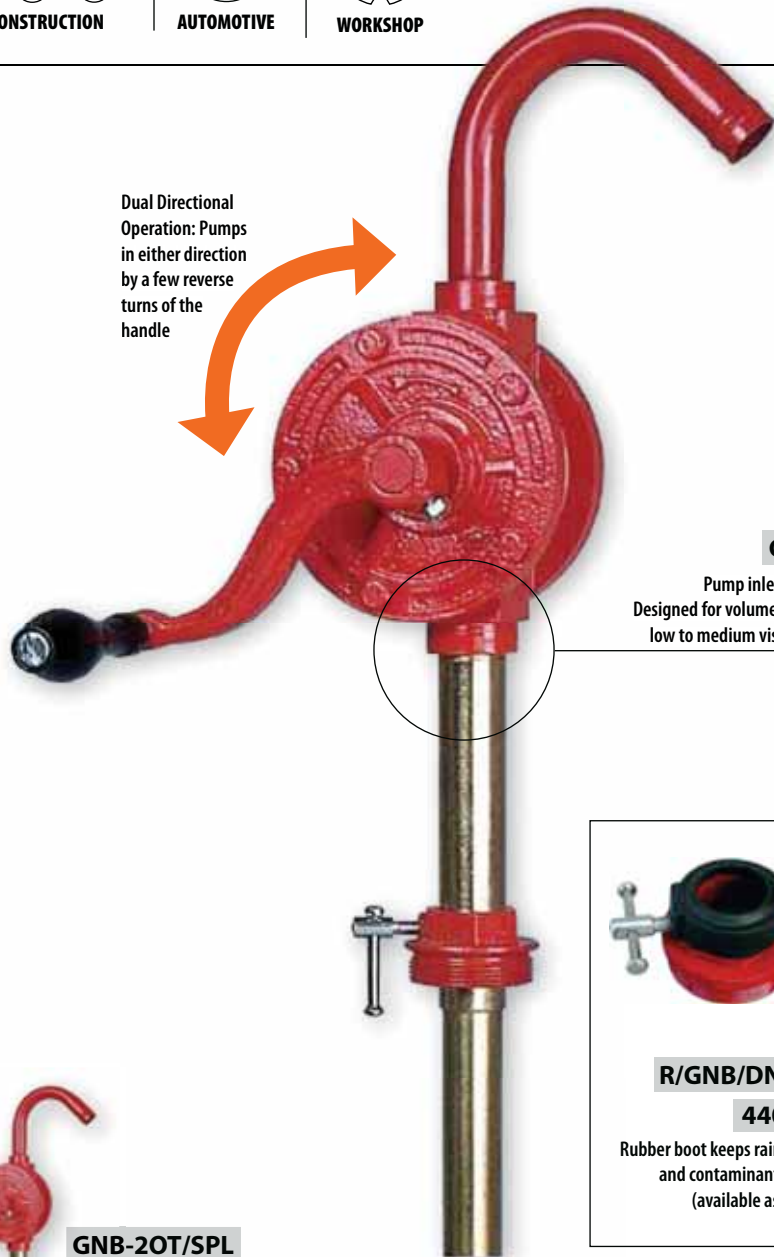

GNB-25

Pump inlet threaded 1" Designed for volume discharge of low to medium viscosity media



R/GNB/DN/01

44092

Rubber boot keeps rain water and contaminants away (available as spare)



GNB-25/3R/PRO

Pump with 1" inlet, complete with 1.8 m hose and metal nozzle

GNB-20T/SPL

Pump inlet threaded 3/4", designed for use with high viscosity media



USEFUL TIPS!

When using with low viscosity media like Diesel, Kerosene etc., pump should be primed by adding 30 ml of media being pumped or any oil into the pump outlet

DELIVERS



Per 20 turns for Diesel Fuel:
GNB-20: 2.85 litre (0.75 gal.)
GNB-25: 5 litre (1.30 gal.)

CAT. NR.	ORD. NR.	PUMP INLET	SEALS	DISCHARGE SPOUT	SUCTION TUBE
GNB-20T/SPL	44000	3/4"	NBR	Steel	Telescopic
* GNB-25T/SPL	44050	1"	NBR	Steel	Telescopic
* GNB-25/3R/SPL	44052	1"	NBR	Steel	3 pc. Rigid
◆ GNB-25V/3R/SPL	44064	1"	VITON	Steel	3 pc. Rigid
GNB-25/3R/PRO	44058	1"	NBR	With 1.8 m hose & metal nozzle	3 pc. Rigid
GNB-25T/PRO	44059	1"	NBR	With 1.8 m hose & metal nozzle	Telescopic

Key * Best Seller ◆ New

78

ROTARY BARREL PUMP - PROFESSIONAL

RB-1



AUTOMOTIVE



WORKSHOP



AGRICULTURE

OILING EQUIPMENT

Rotary barrel pump with Aluminum Die Cast pump body, heavy duty zinc die cast rotor & vanes

Ideal for use in Industrial & Automotive applications

Includes a 2" Cast Iron bung adaptor & die cast aluminum handle with security locking latch

Complete with a 3 pc threaded suction tube for use on 15 gallons (50 litre) – 55 gallons (205 litre) barrels

WETTED COMPONENTS

Aluminum, Zinc, Steel, NBR/Viton & PVC nitrile* (*only for RB/1H)

RECOMMENDED USE

Gasoline, Diesel, Kerosene, Lubricating oils upto SAE 60 & Antifreeze* (*only for RB/1V)

DO NOT USE

With Corrosive liquids, Solvents, Acids, Alkalis etc.

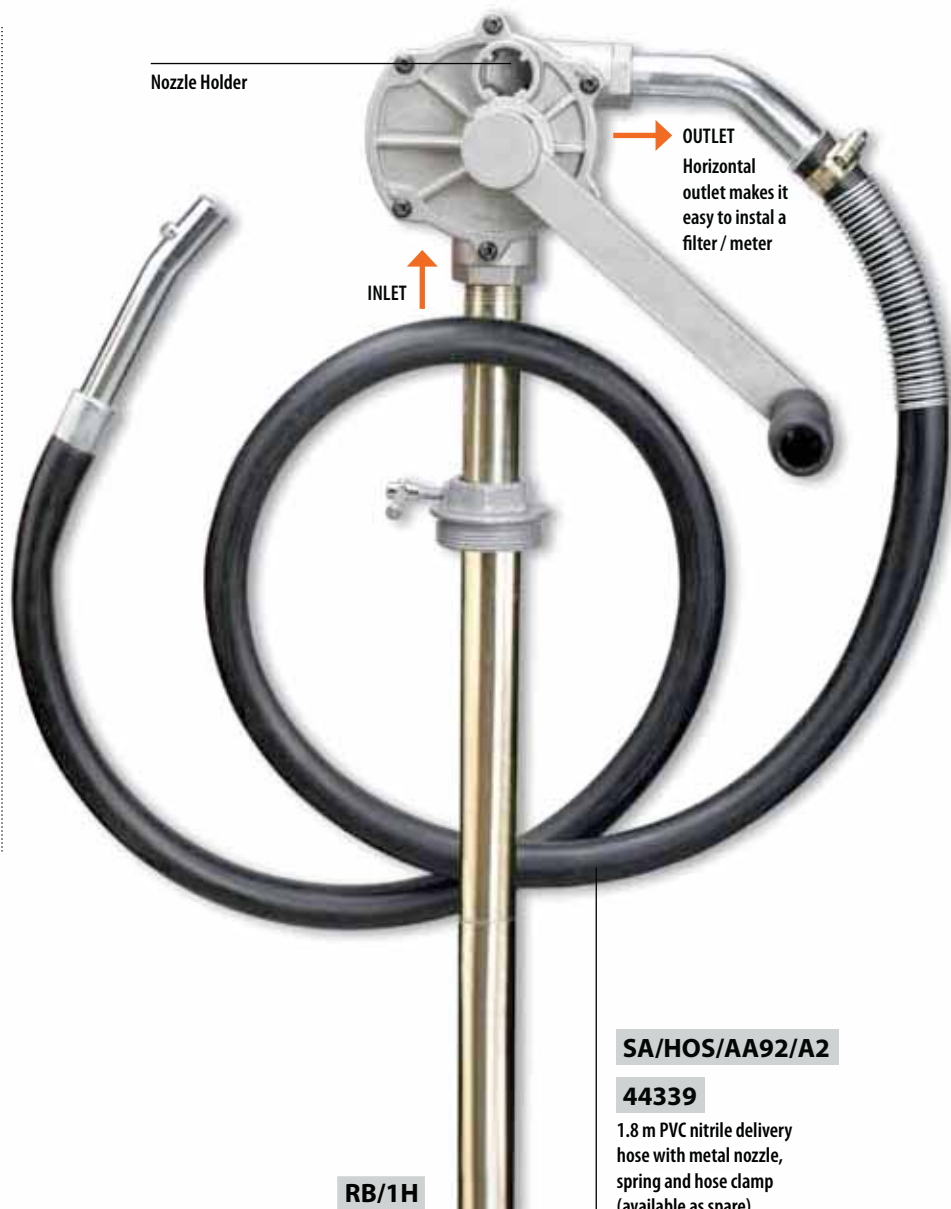

CAT. NR.	ORD. NR.	SEALS	DISCHARGE SPOUT
RB/1	44030	NBR	Steel
◆ RB/1V	44032	VITON	Steel
RB/1H	44031	NBR	1.8 m hose with nozzle, spring & hose clamp

Key ◆ New

DELIVERS
4 litre (1.05 gal.)
per 20 rotations

! WARNING

Fuels containing Ethanol will cause more frequent replacement of rubber parts

Never operate the pump near fire or source of spark. Some media may be explosive & dangerous to pump

79

ROTARY BOOSTER PUMP 3:1

RB-3



Geared Rotary barrel pump with 3 times discharge per rotation. For every complete handle turn, the rotor turns 3 times

Ideal for use where volume fuel dispensing is needed, such as construction sites, workshop, aviation, farms / ranches, boat etc.

Die Cast Aluminum construction with sintered gear driven die cast zinc rotor & vanes

Complete with a 3 pc threaded suction tube for use on 15 gallons (50 litre) – 55 gallons (205 litre) barrels

Available with

- a. Steel discharge spout
- b. 1.8m flexible delivery hose & metal nozzle

WETTED COMPONENTS

Aluminum, Zinc, Steel, NBR & PVC Nitrile*
(*only on RB/3H)

RECOMMENDED USE

Gasoline, Diesel & Kerosene

DO NOT USE

With Corrosive liquids, solvents, acids, alkalis etc.

DELIVERS



Upto 55 gallon / 205 litres in 3 minutes

PUMP INTERNALS

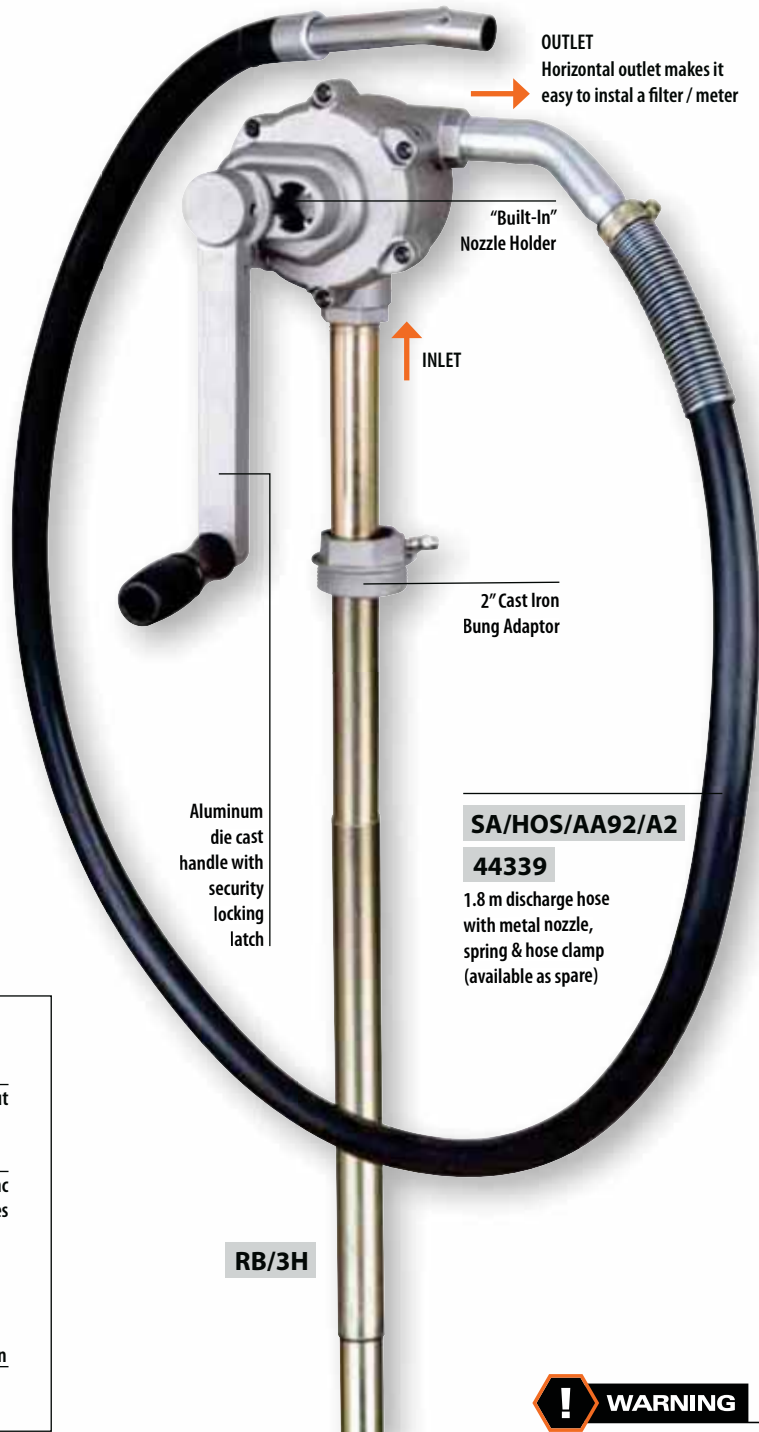
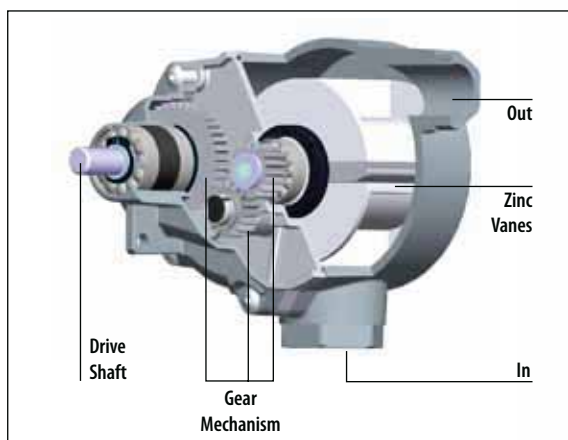

RB/3H

! WARNING

Note that fuels containing Ethanol will cause more frequent replacement of rubber parts

Never operate the pump near fire or source of spark. Some media may be explosive & dangerous to pump

CAT. NR.	ORD. NR.	DESCRIPTION
◆ RB/3	44201	With metal outlet spout
RB/3H	44198	With 1.8 m delivery hose & metal nozzle

Key ◆ New

80

DOUBLE DIAPHRAGM FUEL TRANSFER PUMP

DPP-1

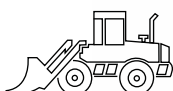

CONSTRUCTION



AUTOMOTIVE

OILING EQUIPMENT

Heavy Duty Fuel Transfer pump with discharge up to 1 gallon per 5 strokes (800 ml / stroke)

Ideal for use where compressed air / power is not easily available such as farms / ranches, construction sites, boat etc.

Stainless Steel Piston & fuel resistant hi-nitrile rubber diaphragm

Includes a 2" die cast bung adaptor & extra heavy duty steel handle with security locking latch

Pump inlet fitted with easy to clean wire mesh screen

Complete with telescopic suction tube with non-return valve
For use with 15 gal. (50 litre) - 55 gal. (205 litre) drums

WETTED COMPONENT

Aluminum, Steel, Stainless Steel, Poly Acetal & NBR

RECOMMENDED USE

Gasoline, Diesel fuel, Fuel Oil, Motor Oil & other light petroleum products

DO NOT USE

With Corrosive liquids, solvents, acids, alkalis etc.

DELIVERS



Upto 1 gallon in 5 strokes
Upto 800 ml per stroke

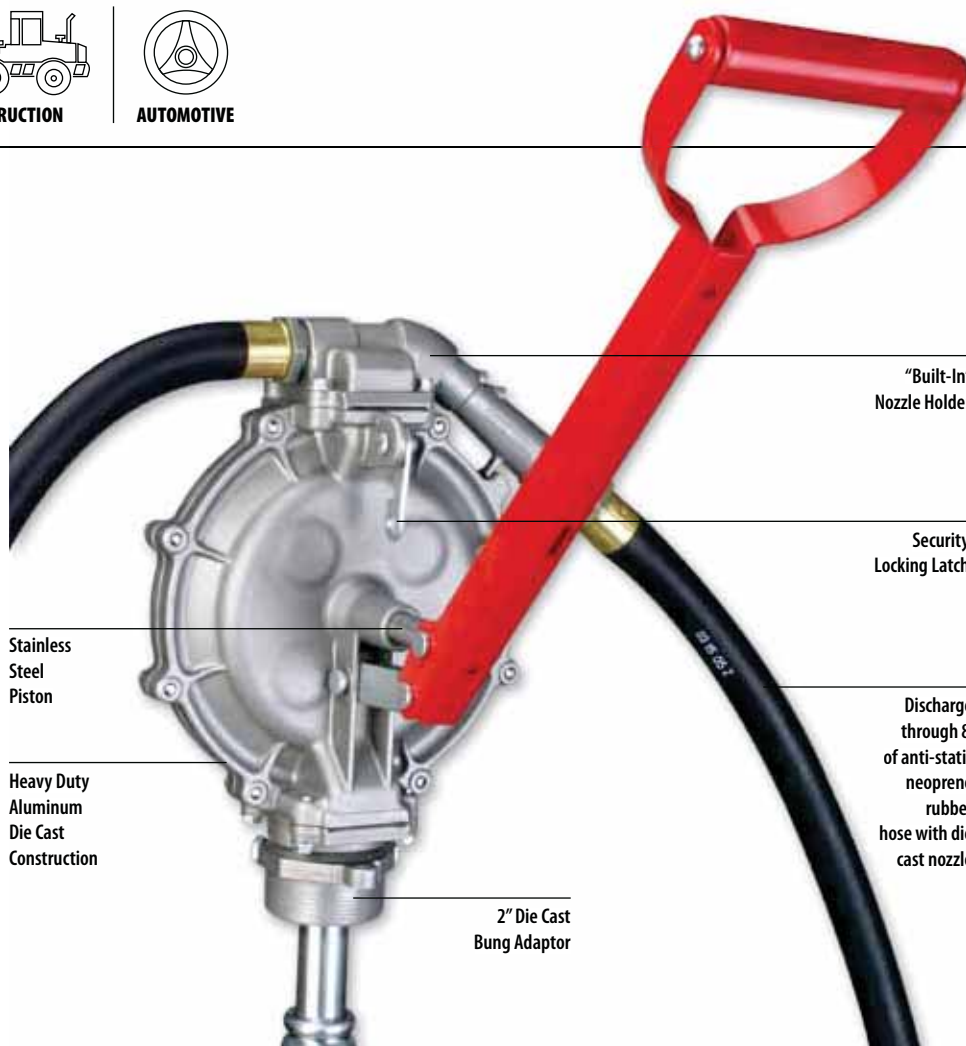

! WARNING

Note that Fuels containing Ethanol will cause more frequent replacement of rubber parts

Do not use with Fuels with Ethanol content greater than 10%

Never operate the pump near fire or source of spark. Some media may be explosive & dangerous to pump

Pump is designed primarily for use with low viscosity media. Pumping heavy fluids may cause undue stress resulting in fracture

PUMP INTERNALS

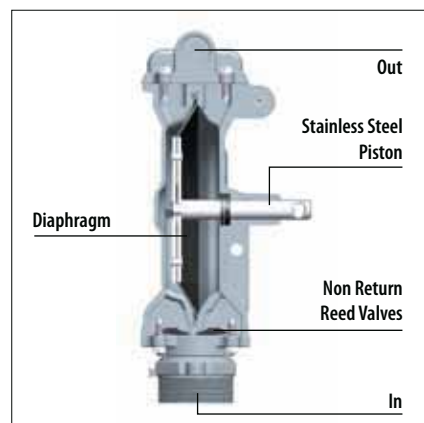

CAT. NR.	ORD. NR.	DESCRIPTION
DPP/1	44195	Complete Pump Assembly
SERVICE PARTS		
SA/HOS/RBP/3V	44338	8' x 3/4" Replacement Hose
GKT/DPP/1	44194	Non Return Reed Valve Kit

Note:
Pump has a vent/air hole built-in which will drain back any excess media into the drum

INDUSTRIAL ROTARY BARREL PUMPS

RBP-3V



Industry Standard for Rotary pumps, these are by far the heaviest duty, ideal for tough outdoor use in extreme weather conditions

Deliver media with a head / lift upto 20'

Solid cast iron construction, fully CNC machined to close tolerances

Pump Handle rotates a high quality sintered powder metal 3 vane rotor inside a highly finished pumping chamber

Graphite Vanes are self lubricating & non wearing

High quality graphite seal allows the pump to be used with a wide variety of fluids including Diesel with upto 15% Ethanol blend

Self Priming operation with discharge up to 38 LPM (10 GPM)

Supplied complete with 2" Bung, Telescopic Suction Tube with Strainer for use with 15 gallons (50 litre) – 55 gallons (205 litre) barrels

WETTED COMPONENTS

Cast Iron, Steel, Graphite, Paper, Polypropylene

DO NOT USE

With Water Based Media

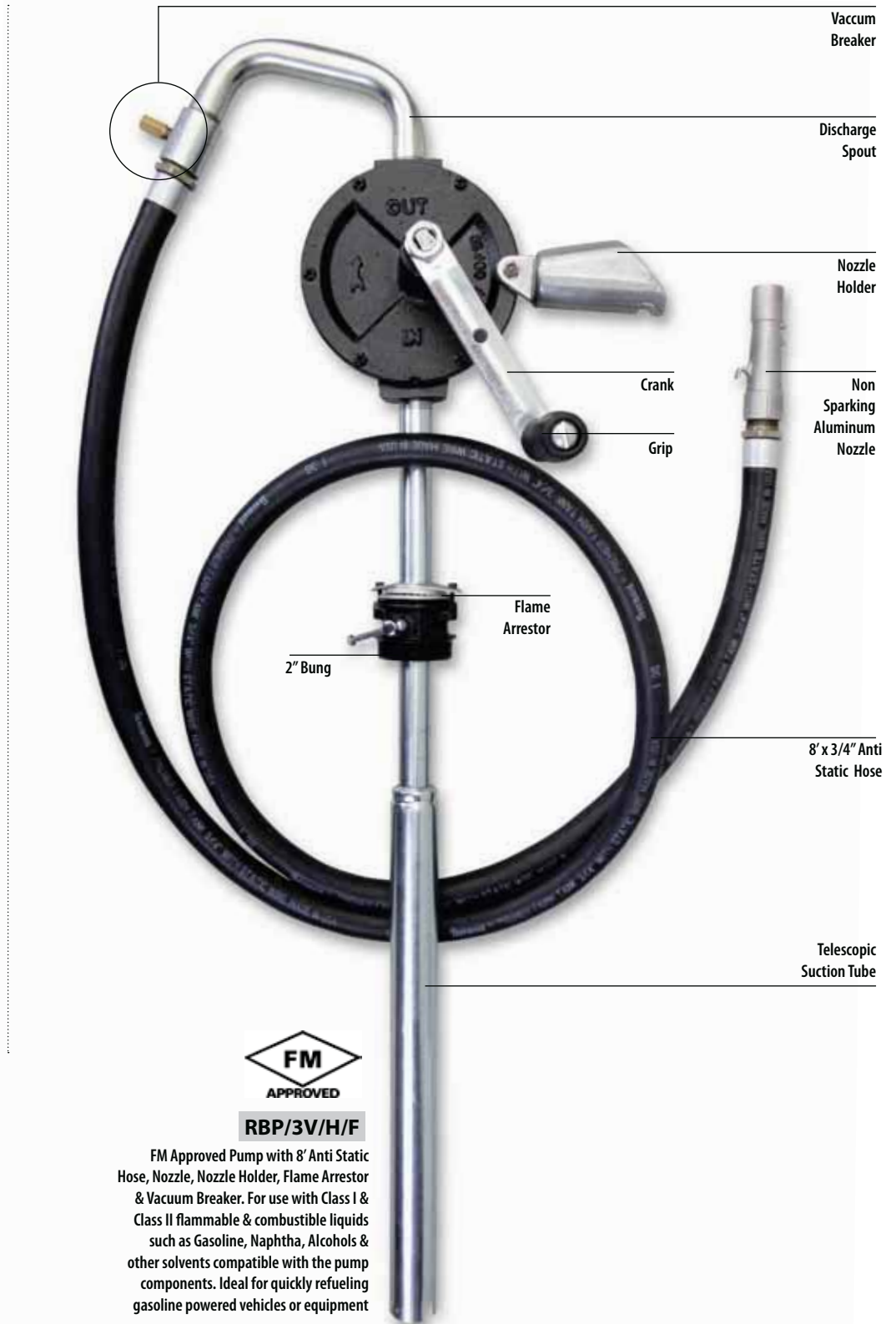

RBP/3V/H/F

FM Approved Pump with 8' Anti Static Hose, Nozzle, Nozzle Holder, Flame Arrestor & Vacuum Breaker. For use with Class I & Class II flammable & combustible liquids such as Gasoline, Naphtha, Alcohols & other solvents compatible with the pump components. Ideal for quickly refueling gasoline powered vehicles or equipment

DELIVERS



Upto 38 LPM (10 GPM)



RBP/3V

Pump with Steel Discharge Spout for use with Petroleum based fluids, Diesel & Kerosene. Ideal for use with Barrels, drums & tanks for transferring media into smaller containers



RBP/3V/F

FM Approved Pump with Drip Pan & Flame Arrestor. For use with Class I & Class II flammable & combustible liquids such as Gasoline, Naphtha, Alcohols & other solvents compatible with the pump components



RBP/3V/H

Pump with 8' Antistatic Hose, Nozzle & Nozzle Holder for use with Petroleum base fluids, Diesel & Kerosene. Ideal for use with Barrels, Drums & tanks for quickly refueling Diesel powered vehicles or equipment

PUMP CHAMBER WITH 3 VANE CONSTRUCTION

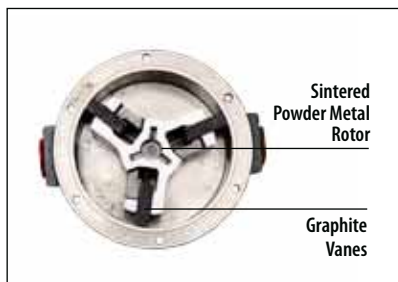

KIT/RBP/3V

Includes pump head gasket, graphite vanes (3), vane springs (3), shaft nut, packing & packing nut

CAT. NR.	ORD. NR.	DESCRIPTION
RBP/3V	44080	Steel Spout
* RBP/3V/H	44081	8' Anti-Static Hose, Non-Sparking Aluminum Nozzle & Nozzle Holder
FM APPROVED PUMPS		
RBP/3V/H/F	44082	8' Anti-Static Hose, Non-Sparking Aluminum Nozzle & Nozzle Holder, Vacuum Breaker & Flame Arrestor
RBP/3V/F	44084	Steel Discharge Spout, Drip Pan with Flame Arrestor
DP/RBP/3V	44083	Replacement Drip Pan only
SERVICE PARTS		
KIT/RBP/3V	44086	Repair Kit
SA/HOS/RBP/3V	44338	8' x 3/4" Replacement Hose

Key * Best Seller

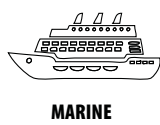

BLP-02

BLP-03

OLP-12

OLP-16

Pump designed for transferring transmission differentials & heavier oils

Zinc plated pump body with aluminum die cast head & adjusting flange

Powder coated steel drum cover

Wear resistant brass piston rings fitted onto zinc die cast piston

Complete with 48" / 4' fuel resistant soft PVC hose with nozzle for efficient discharge

Options available with the pump supplied complete with steel bucket in a choice of 12 & 16 litre capacity

WETTED COMPONENTS

Steel, Aluminum, Zinc, Brass, NBR, PVC

RECOMMENDED USE

Transmission differentials & heavier oils

DO NOT USE

Water based & other corrosive media



HOSE/48/BLP

44340

48" Vinyl Hose with Steel discharge outlet (available as spare)



3 Pivot Points for media of different viscosities

OLP-12

Pump with variable handle setting for convenient use with media of different viscosities. Supplied complete with 12 Litre capacity powder coated steel bucket

OLP-16

Pump with variable handle setting for convenient use with media of different viscosities. Supplied complete with 16 Litre capacity powder coated steel bucket

BLP-02

For use with 25-50 lbs / 5 gallons / 20 litre drums

BLP-03

For use with 120 lbs. / 16 gallons / 60 litre drums

CAT. NR.	ORD. NR.	DRUM CAPACITY	PUMP LENGTH	DRUM COVER DIA.
* BLP/02	44150	25-50 lbs / 5 gal. / 20 litres	18" (450 mm)	12" (310 mm)
BLP/03	44160	120 lbs / 16 gal. / 60 litres	30" (760 mm)	15" (381 mm)
OLP/12	44180	12 litres / 3.17 gal.	18" (450 mm)	8-13/16" (224 mm)
OLP/16	44181	16 litres / 4.23 gal.	20-5/8" (524 mm)	8-13/16" (224 mm)

DELIVERS



FOR BLP SERIES
Upto 60 ml (2.14 oz.) / stroke
FOR OLP SERIES
Upto 125 ml (4.64 oz.) / stroke

Key * Best Seller

83

SPRING LOADED PUMPS

SLP-60



WORKSHOP

An easy to use, highly convenient, single person operation oil pump that dispenses oils with a simple press of the trigger. Single hand operation, requires no continuous lever / rotary pumping action

Pump has a spring loaded design that charges the pump for continuous dispensing of media with a single charge. Pump is charged by pressing the pump handle down. Pump handle stays in the pressed position & keeps rising as media is dispensed from the nozzle. A single charge gives upto 500 ml of output

Pump has an all metal construction with built in 2" Male threads into the pump head

Pump head incorporates drain back port to minimize wastage & spillage of over flown media

Supplied complete with 5' PVC hose fitted with an Oil control gun

Designed for use with 60 Litre Drums popular in Australia & New Zealand

WETTED COMPONENTS

Steel, Aluminum, Zinc, Brass, NBR, Polypropylene & PVC

RECOMMENDED USE

Engine & Gear Oils upto SAE 140, Automatic Transmission Fluids

DO NOT USE

Water based & other corrosive media

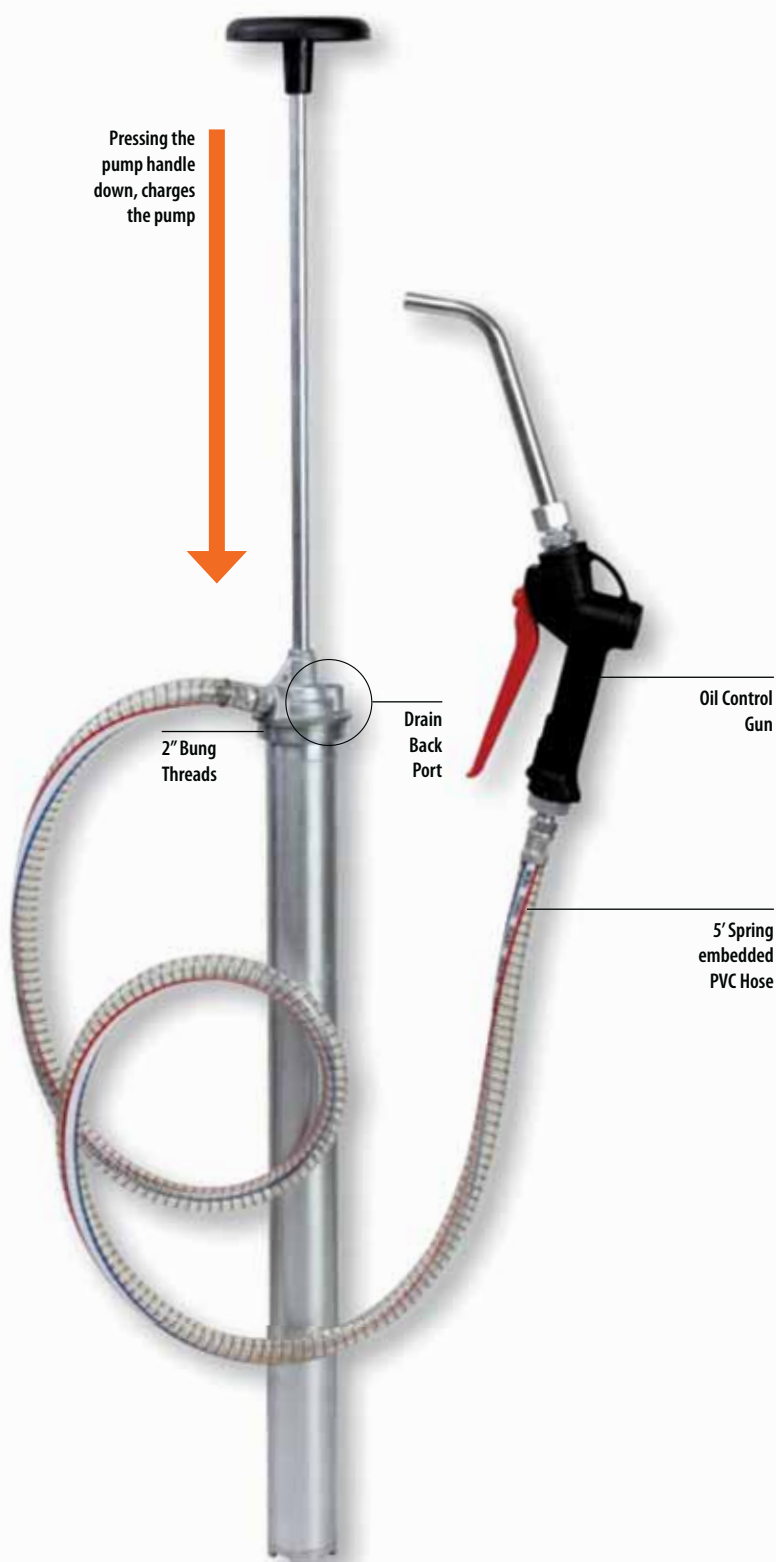

CAT. NR.	ORD. NR.
SLP/60	44135



Versatile Pump, engineered for trouble free use on 5 gallon / 20-25 litre containers with plastic pull out (Rieke® spout) or 2" external threads

Downstroke operation with fluid discharge when pushing the handle down. Enhanced ease of use & reduced fatigue especially when pumping heavy fluids. It additionally reduces pull out stress on the pump bung

Heavy duty steel suction tube, with the pump head made from high density polyethylene. Pump head incorporates Nozzle Holder & option to drain back over flown fluid into the container

Interchangeable Bung Adaptors. The standard bung adaptors can be slid over the pump, when using on containers with external threading. Alternatively, when using the pump on pails with plastic pull out Rieke® spout, the other bung adaptor for Rieke® spout can be used. Choice of 7 adaptors makes the pump good for use with most metal & plastic containers

Pump length can be extended by over 4" for use on high depth containers, by conveniently sliding the suction tube extender

Supplied complete with Rigid Steel Discharge Spout & 48" long Spring embedded non Kink Discharge Hose fitted with Non Drip

WETTED COMPONENTS

Steel, Aluminum, Polyethylene, Polypropylene Co Polymer, High Nitrile Rubber, PVC & Acetal

RECOMMENDED USE

Engine oils, gear oils, Diesel and light fuel oil

DO NOT USE

Water based & other corrosive media

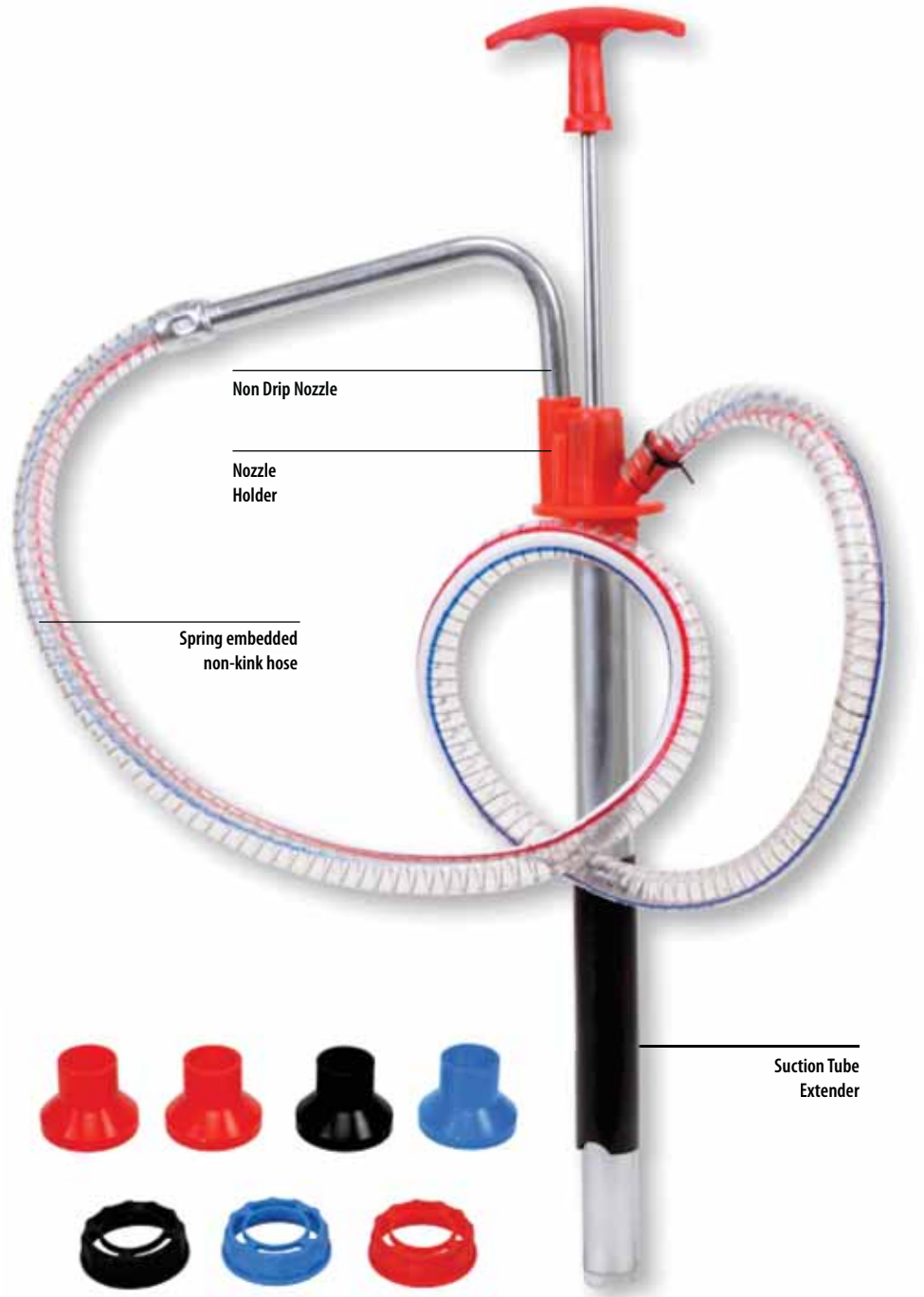

CAT. NR.	ORD. NR.	PUMP LENGTH	SUCTION TUBE OUTER DIA.
EZF/DS/20	44183	12.7" (323 mm) to 17" (435 mm)	1" (25.4 mm)

Key

DELIVERS



Upto 1 litre (1 quart) / 18 strokes

85

DRIP PANS

A must have accessory with every drum pump; the Drip Pan fits into any 2" threaded opening on a drum, barrel or tank

Used as a drain for returning over flown media back to the drum

It additionally works as a base for holding a container during dispensing

Keeps work place clean & eliminates wastage, saving money each time the pump is used

Designed with a built-in 2" Bung Adaptor & strainer for draining clean media back into the drum

Available in 2 styles

Cast Iron Body Designed for use with pumps with a Suction Tube diameter equal or less than 1.32" (33.5 mm)

Cast Aluminum Body with 2" external & internal threads. Design allows any pump with a 2" bung to fit onto the Drip Pan

DP/GNB/25

With Cast Iron Body



2" Bung Adaptor

DP/AL/2

With Aluminium Body

7" (175 mm)

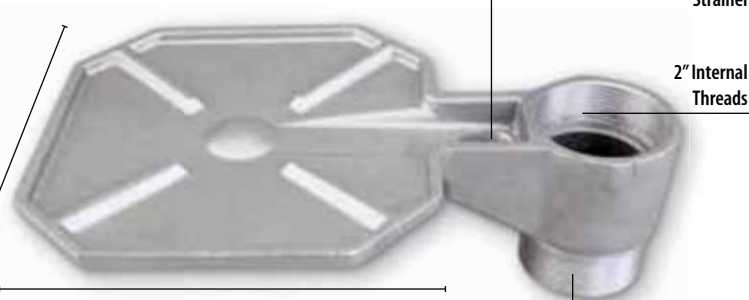

Strainer

2" Internal Threads

7" (175 mm)

2" Bung Adaptor

CAT. NR.	ORD. NR.	CONSTRUCTION
DP/GNB/25	44075	Cast Iron Body
DP/AL/2	44076	Cast Aluminium Body

86

BUNG NUTS

Cast iron bung nuts / adaptors for use on standard 2" barrels

Plated spindle with tommy bar to firmly hold suction tube



CAT. NR.	ORD. NR.	COLOR / DESCRIPTION	SUITABLE FOR SUCTION TUBES WITH DIA. UP TO	FOR USE WITH GROZ PUMP SERIES
GNB/DN-34	44380	Red	1.09" (27.5 mm)	GNB-20
GNB/DN-01	44381	Red	1.27" (32.5 mm)	GNB-25
GNB/DN-02	44382	Red	1.5" (38 mm)	LLP, VLP
GNB/DN-02/SLV	44383	Silver Grey	1.5" (38 mm)	RB-1, RB-3
BN/RBP/3V	44384	Black	1" (26 mm)	RBV/3V
BN/RBP/3V/F	44388	Black with Flame Arrestor	1" (26 mm)	RBV/3V (FM Approved Pumps)

87

SUCTION TUBES

Suction tubes, for use with all types of oil pumps

Available in telescopic or Rigid style

Other sizes can be custom manufactured



CAT. NR.	ORD. NR.	DESCRIPTION	TUBE MATERIAL	SEAL	LENGTH	THREADS	FOR USE WITH GROZ PUMP SERIES
TELESCOPIC							
GNB/TP-34	44300	Telescopic	Steel	Nitrile Rubber	23.3/4" to 39.3/4" (605 mm to 1012 mm)	3/4" BSPT (M)	GNB-20
GNB/TP/3-4F/N	44305	Telescopic with Filter Screen at Inlet	Steel	Nitrile Rubber	24.2" to 40.4" (615 mm to 1026 mm)	3/4" NPT (M)	RBP-3V
LBP/TP-34	44302	Telescopic	Steel	Nitrile Rubber	18.5/16" - 34.7/16" (465 mm to 875 mm)	3/4" NPT (M)	LBP-04, LBP-06, LBP-96
LBP/TP-34/NR	44304	Telescopic with Non Return Valve at Inlet	Steel	Nitrile Rubber	19.3/8" - 34.27/32" (492 mm) to 885 mm)	3/4" NPT (M)	QSP-01, DPP-1
LBP/TP/3-4/PVC	44306	Telescopic	PVC	Nitrile Rubber	19.5/16" to 35-5/8" (490 mm to 905 mm)	3/4" NPT (M)	LBP-04, LBP-06, LBP-96
PLP/TP/3-4	44307	Telescopic	Polypropylene & Polyethylene	Viton	13-3/4" (350 mm), 25.4" (645 mm), 39.37" (1000 mm)	3/4" PF (M)	PLP-02
GNB/TP-01	44301	Telescopic	Steel	Nitrile Rubber	23.3/4" to 40.1/8" (604 mm to 1020 mm)	1" BSPT (M)	GNB-25
LBP/TP/1-20/NR	44308	Telescopic with Non Return Valve at Inlet	Steel	Nitrile Rubber	19-1/2" to 34.84" (495 mm to 885 mm)	1"-20 UNEF (M)	ORP-51
A2/TP/1-20	44309	Telescopic	Steel	Nitrile Rubber	13.19" to 26" (335 mm to 660 mm)	1"-20 UNEF (M)	A2
A2/TP/SPL/1-20V	44310	Telescopic	Steel	Viton	17.7" to 34.84" (450 mm to 885 mm)	1"-20 UNEF (M)	LBP-85
RIGID							
EBP/2R/01	44311	2 pc Rigid Pipe	PVC	-	17-1/2" to 35.24" (445 mm to 895 mm)	31/32 - 20 UNF (M)	EBP-01
GNB/3R/01	44303	3 pc Rigid Pipe	Steel	-	13.3/4" (350 mm), 26.3/8" (670 mm) & 39.3/8" (1000 mm)	1" BSPT (M)	GNB-25, RB-1, RB-3
FPM/2R/1/N	44312	2 pc Rigid Pipe	PVC	-	17" to 34" (430 mm to 863 mm)	1" NPT (M)	FPM, OPM
PRP/3R	44313	3 pc Rigid Pipe	Polypropylene	-	16.73" (425 mm), 31.10" (790 mm) & 45.28" (1150 mm)	Special Non Std.	PRP, ERP

88

COMPOSITE AIR OPERATED OIL RATIO PUMP - 5:1

ORP-51



INDUSTRIAL



AUTOMOTIVE



WORKSHOP

OILING EQUIPMENT

Compact Air operated 5:1 Ratio pump for dispensing Oils upto 5 times the pressure as the Air Inlet

Double Acting Operation with discharge upto 15 LPM (4 GPM)

Operates off most small compressors with size as small as 0.08 cubic meter/minute (3 cfm)

Commonly used in workshops, farm, construction machinery or as a part of a Mobile oil system

Reciprocating piston operated 72 mm (2.83") dia. air motor

Non corroding air motor design (composite construction) allows the pump to be used without an air line lubricator

Built-In pressure relief valve prevents both the pump & system against damage created by excessive pressure due to thermal expansion

Stub pump designed with dual oil inlet threads 1" NPT (F) & 1" UNEF (F), allowing the user to make his own suction tube for any drum / tank depth

Ideal for use over long distances upto 50 metres

Comes complete with 2" bung nut to fit directly onto oil barrels

WETTED COMPONENTS
Aluminum, Zinc, Steel, Brass, nitrile & Polyurethane Rubber

RECOMMENDED USE
For use with Oils to SAE 140 viscosity, ATF, Diesel, Kerosene, and Soft Self Collapsing Grease

Double Acting
↑
↓

Air Inlet
1/4" NPT (F)

Oil Inlet
1/2" NPT (F)



Air Inlet Connection	1/4" NPT (F)
Pump Outlet Connection	1/2" NPT (F)
Working Pressure	60-150 PSI (4-10 BAR)
Maximum Air Pressure	150 PSI (10 BAR)
Air Consumption	270 lt/min (72 GPM)
Discharge	15 LPM (4 GPM)
Maximum Viscosity of Oil	140 SAE
Noise Level	85 db

CAT. NR.	ORDERING NR	DESCRIPTION	OIL OUTLET
* ORP/51/N	45310	Stub Pump Only	1/2" NPT (F)
ORP/51T/N	45311	Pump complete with 1" Telescopic Suction Tube	1/2" NPT (F)

Key * Best Seller

! WARNING

Pump must be supplied with clean & dry compressed air via an FR unit

89

AIR OPERATED OIL RATIO PUMPS



INDUSTRIAL



AUTOMOTIVE



WORKSHOP



CONSTRUCTION

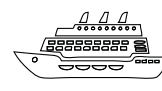

MARINE

World-class Industrial Oil dispensing pumps with guaranteed performance & hassle free operation

Pumps are designed to work in tough conditions & are ideal for use in Industry, workshop, farm, construction or as part of the Mobile Oil system

All metal construction, fully CNC machined with hardened wear resistant moving parts

Reciprocating piston operated 2-1/2" (63 mm) dia. Air Motor

Stub Pumps are supplied with Non Return Valve threaded 1" (F) for use on the bottom of the Suction Tube.

Other pump lengths have a built in Strainer at pump inlet to keep contaminants away

WETTED COMPONENTS

Steel, Brass, Aluminum, Hi Nitrile Rubber, Polyurethane, Turcite* & Nylon**
 (*Only on 3:1 & 5:1 pumps,
 ** Only on 1:1 pumps)



WARNING

Pump must be supplied with clean & dry compressed air via an FRL unit

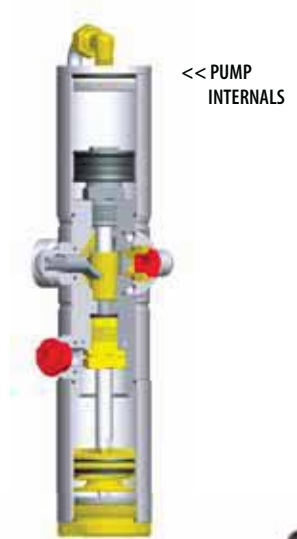

PUMP SPECIFICATIONS

Working Pressure	2 - 10 BAR (30 - 150 PSI)
Max. Air Pressure	10 BAR (150 PSI)
Air Inlet Connection	¼" BSP (F) / ¼" NPT (F)
Pump Outlet Connection	½" BSP (F) / ½" NPT (F)
Pump Inlet on Stub Pumps only	1" BSP (F) / 1" NPT (F)
Noise Level	81 db

Variants - 1:1 Pumps

Transfer pump, used to quickly transfer oils from large drums to smaller containers. These have a Double Acting operation with discharge upto 40 LPM (10.58 GPM).

Ideal for use with low to medium viscosity oils (upto SAE 80) for transfer over short distances (5 metres)

Air Consumption: 270 LPM (71.5 GPM)

1:1 pump is also available complete with Oil Bar Tap & connecting links (ODS series), used as an Air Operated Oil Dispenser to quickly & conveniently dispense Oils from Drums.

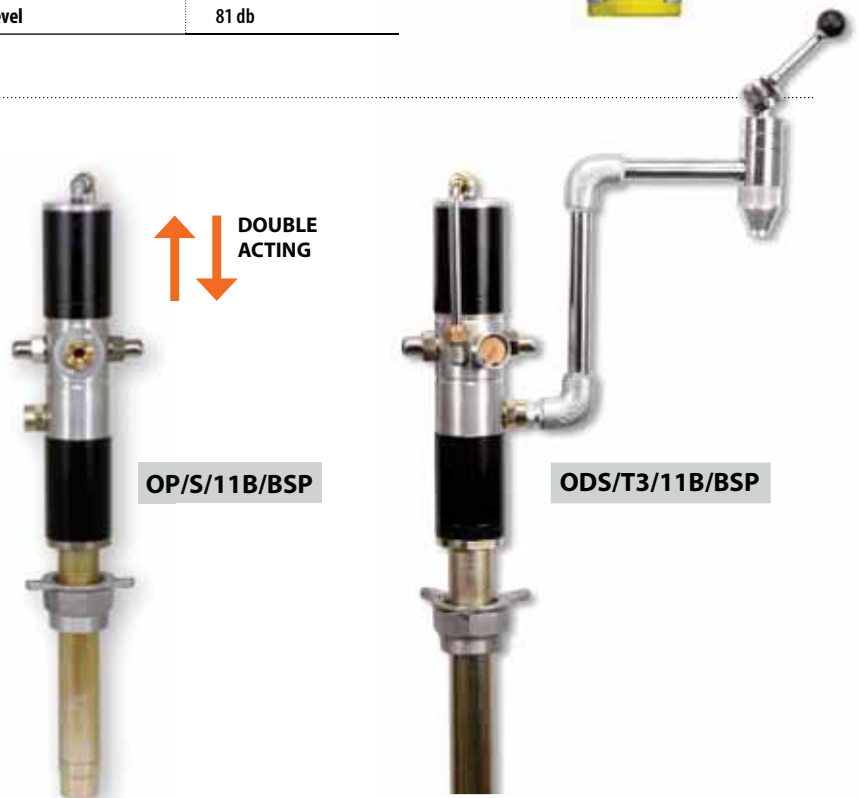

DELIVERS



Upto 40 LPM (10.5 GPM)

CAT. NR.	ORD. NR.	CAT. NR.	ORD. NR.	DESCRIPTION
BSP THREADS		NPT THREADS		
OP/S/11B/BSP	45322	OP/S/11B/N	45323	Stub Pump with Bung Adaptor
OP/T2/11B/BSP	45332	OP/T2/11B/N	45333	Pump complete with Suction Tube for 16 gal (50-60 litre) drums & bung adaptor
* OP/T3/11B/BSP	45342	* OP/T3/11B/N	45343	Pump complete with Suction Tube for 55 gal (205 litre) drums & bung adaptor
ODS/T3/11B/BSP	45355	ODS/T3/11B/N	45356	Pump complete with Suction Tube for 55 gal (205 litre) drums, bung adaptor & Oil Bar Tap & fittings

Key * Best Seller



- OP-11
- OP-31
- OP-51
- ODS-11

OILING EQUIPMENT

Variants - 3:1 Pumps

Amongst the most popular general purpose air operated pumps worldwide

Pumps are single acting with discharge upto 14 LPM (3.70 GPM)

Ideal for use with medium to high viscosity oils (upto SAE 130) for transferring over short distances (upto 30 metres), mostly used with Trolley mounted kits

Air Consumption: 230 LPM (61 GPM)

DELIVERS

Upto 14 LPM (3.70 GPM)

OP/T3/31B/N



CAT. NR.	ORD. NR.	CAT. NR.	ORD. NR.	DESCRIPTION
BSP THREADS		NPT THREADS		
OP/S/31B/BSP	45320	* OP/S/31B/N	45321	Stub Pump with Bung Adaptor
OP/T2/31B/BSP	45330	OP/T2/31B/N	45331	Pump complete with Suction Tube for 16 gal (50-60 litre) drums & bung adaptor
* OP/T3/31B/BSP	45340	* OP/T3/31B/N	45341	Pump complete with Suction Tube for 55 gal (205 litre) drums & bung adaptor

Key * Best Seller

Variants - 5:1 Pumps

High Pressure air operated pumps for dispensing oil at 5 times the pressure as the air inlet

Pumps are double acting with discharge upto 18 LPM (4.76 GPM)

Ideal for use with high viscosity oils (upto SAE 240) for transferring over short & long distances (upto 50 metres), mostly used with Trolley mounted kits both with & without Hose Reels, as well as with fixed systems for centralized distribution

Air Consumption: 250 LPM (66 GPM)

DELIVERS

Upto 18 LPM (4.76 GPM)

DOUBLE ACTING

OP/S/51B/N



CAT. NR.	ORD. NR.	CAT. NR.	ORD. NR.	DESCRIPTION
BSP THREADS		NPT THREADS		
OP/S/51B/BSP	45324	* OP/S/51B/N	45325	Stub Pump with Bung Adaptor
OP/T2/51B/BSP	45334	OP/T2/51B/N	45335	Pump complete with Suction Tube for 16 gal (50-60 litre) drums & bung adaptor
* OP/T3/51B/BSP	45344	* OP/T3/51B/N	45345	Pump complete with Suction Tube for 55 gal (205 litre) drums & bung adaptor

Key * Best Seller

90

AIR OPERATED STAINLESS STEEL PUMP

NEW!

OP-T3-SS



INDUSTRIAL

3:1 Air Operated pump, corrosion protected for use with water based fluids, such as Detergents, Windshield Fluids, Water etc.

Wetted components are made out of Stainless Steel

Pump is designed to work in corrosive environments, ideal for use in Car Washers, Garages, Workshops, Lube Trucks & Industrial applications

Reciprocating piston operated 2-1/2" (63 mm) dia. Air Motor

Pumps have a built in Stainless Steel Strainer at inlet to keep contaminants away

Includes 2" Die Cast Aluminium bung for use with 205 Litre (55 gallons) drums

WETTED COMPONENTS

Stainless Steel, Brass, Aluminium, Hi Nitrile Rubber, Polyurethane, Turcite

RECOMMENDED USE

Water, water soluble lubricants, coolants, soap solutions, detergents, windshield fluids etc.

DO NOT USE

Food Grade media, waste oil or any media not compatible with the pump components



CE

Stainless Steel Suction Tube

Stainless Steel Strainer



DELIVERS



Upto 14 LPM (3.70 GPM)

PUMP SPECIFICATIONS

Working Pressure	2 – 10 BAR (30 to 150 PSI)
Max. Air Inlet Pressure	10 BAR (150 PSI)
Air Consumption	230 LPM (61 GPM)
Air Inlet Connection	¼" BSP (F) / ¼" NPT (F)
Pump Outlet Connection	½" BSP (F) / ½" NPT (F)
Noise Level	81 db

! WARNING

Pump must be supplied with clean & dry compressed air via an FRL unit

CAT. NR.	ORD. NR.	CAT. NR.	ORD. NR.
BSP THREADS		NPT THREADS	
OP/T3/SS/BSP	45360	OP/T3/SS/N	45365

91

AIR OPERATED OIL PUMP ACCESSORIES

Mounting Bracket

All Steel Wall mounting Bracket for installing Stub Pumps

Bracket has a bung welded at the centre threaded 2" (F)

Black powder coated finish

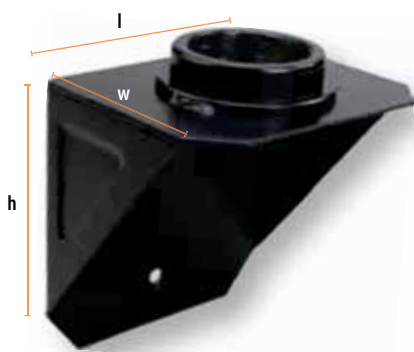

CAT. NR.	ORD. NR.	LENGTH (l)	WIDTH (w)	HEIGHT (h)
BKT/S/RP	45395	4-3/4" (120 mm)	6" (150 mm)	6" (150 mm)

Foot Valve

Used at the bottom of a suction tube as a non return valve, these help in retaining prime

Machined Aluminum construction with a steel non return ball

Available in a choice of 3/4" (F) or 1" (F) threads



CAT. NR.	ORD. NR.	THREADS
FV/3-4F/BSP	45392	3/4" BSP (F)
FV/0-1F/BSP	45393	1" BSP (F)
FV/3-4F/N	45390	3/4" NPT (F)
FV/0-1/N	45391	1" NPT (F)

Bung Nuts

Aluminum Die cast 2" Drum Bungs for use primarily with Air Operated Pumps

Bungs can be adjusted anywhere on the suction tube & tightened using the Wing Nut

Zinc Die cast Locking Nut inside holds the suction tube

Available in a choice of sizes for use on suction tubes of varying diameters



CAT. NR.	ORD. NR.	INSIDE DIAMETER
BUNG/OP/30	45396	30 mm
BUNG/OP/36	45397	36 mm
*BUNG/OP/42	45398	42 mm

* standard on all Groz Air Operated OP Series Oil Pumps

Hydraulic Hoses

Hydraulic Rubber Hoses for use with Air Operated Oil Pumps

Hose exceeds SAE 100 R1 specification

Working Pressure
2,200 PSI (150 BAR)

Inner Dia. 1/2"
Outer Dia. 7/8"

Hydraulically crimped with steel fittings with 1/2" (M) threads on both ends



CAT. NR.	ORD. NR.	LENGTH	THREADS
HH/1.5/1-2M/1-2M/BSP	45380	1.5 m	1/2" BSP (M)
HH/2.5/1-2M/1-2M/BSP	45381	2.5 m	1/2" BSP (M)
HH/3.5/1-2M/1-2M/BSP	45382	3.5 m	1/2" BSP (M)
HH/1.5/1-2M/1-2M/N	45385	1.5 m	1/2" NPT (M)
HH/2.5/1-2M/1-2M/N	45386	2.5 m	1/2" NPT (M)
HH/3.5/1-2M/1-2M/N	45387	3.5 m	1/2" NPT (M)

AIR OPERATED DOUBLE DIAPHRAGM PUMPS



INDUSTRIAL



AGRICULTURE



WORKSHOP

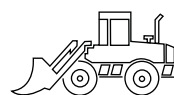

CONSTRUCTION

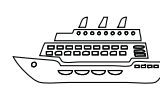

MARINE

Double Diaphragm Pumps are driven by Compressed Air, designed for use in applications requiring large volume transfer in a very short time.

These pumps can transfer contaminated media & are good at cleaning out pits or liquids that can be a mix of several products like oil, water and antifreeze all mixed together.

Handles a wide variety of fluids with high solids content: No close fitting or rotating parts so liquid with high solids content and/or size can be easily pumped.

Self Priming: The pump design (incorporating internal check valves) allows for high suction lift even at dry start-up and with heavier fluids.

Ability to run dry: No close fittings or sliding parts are at risk. The pump can run dry without damage.

Variable flow rate and discharge pressure: Pumps will run at any setting within their operating range simply by adjusting the air inlet pressure and system conditions. One pump can fit a broad spectrum of applications.

Portable/Simple Installation: Pumps transport easily to the application site. Simply connect your air supply line and liquid lines; the pump is ready to perform. There are no complex controls to install and operate.

Dead Head: Because the discharge pressure can never exceed air inlet pressure, the discharge line can be closed with no damage or wear. The pump will simply slow down and stop.

Shear sensitive: The gentle nature and minimal parts contact with the liquid makes these pumps an excellent choice for shear sensitive fluids

Explosion Proof: As pumps are operated by compressed air, therefore, they are intrinsically safe.

Submersible: If external components are compatible—these pumps can be submerged in the liquid by simply running the exhaust line above the liquid level.

Pumping efficiency remains constant: There are no rotors, gears, or pistons, which wear over time and lead to the gradual decline in performance/flow rate.

Diaphragm pumps however do not produce pressure as they have a 1:1 operation & cannot be used with a flow meter. The standard pump configuration is also not suitable for use with flammable media (Gasoline)

All pump Models are designed for use with an Inlet Air Pressure of 20 – 100 PSI (1.40 to 6.89 BAR). Air Inlet on all pump models is threaded ¼" NPT (F)



	AODD/1-4/FPT/N	AODD/1-2/BAH/N
Size	1/4"	1/2"
Casing	Polypropylene	Aluminium
Diaphragm	PTFE	Hytrel®
Flow rate	0 -11 LPM (0 - 2.90 GPM)	0 - 50 LPM (0 - 13.22 GPM)
Pump Inlet/ Outlet NPT (F)	1/4"	1/2"
Air Exhaust NPT(F)	3/8"	3/8"
Max Particle Size	N/A	1/32" (1 mm)
Suction Lift (DRY)	5-feet	5-feet
Max Air Consumption	250 LPM (8.83 CFM)	450 LPM (15.9 CFM)
Wetted Components	Polypropylene, PTFE	Aluminium, PA, Stainless steel, Hytrel®
Valve Ball Material	PTFE (Flat type)	Hytrel®
Air Motor	Ryton®	Aluminium
Maximum Liquid Temperature	60°C (140°F)	80°C (176°F)

These pumps are available in a choice of 2 body materials:

a. Aluminum: Aluminum Body pumps come with a Hytrel® (TPEE) Diaphragm. Hytrel® allows these pumps to be used at higher temperatures & imparts much longer life as opposed to pumps with BUNA-N diaphragm. Highly suitable for use with oils. Not recommended for use with abrasive & corrosive liquids.

b. Polypropylene: Polypropylene body pumps come with a choice of Diaphragms

- Santoprene® (TPO):** Best for use with abrasives, acids, caustics etc.
- Teflon® (PTFE):** Chemically most inert compound. Suitable for use with highly aggressive liquids such as solvents etc.

Temperature Range For Various Materials

BODY / CASING MATERIAL	LIQUID TEMPERATURE RANGE
Aluminium	0 to 100°C (32°F to 212°F)
Polypropylene	0 to 60°C (32°F to 140°F)
DIAPHRAGM MATERIAL	LIQUID TEMPERATURE RANGE
BUNA N	0 to 70°C (32°F to 158°F)
Hytrel® (TPEE)	0 to 80°C (32°F to 176°F)
Santoprene® (TPO)	0 to 90°C (32°F to 194°F)
Teflon® (PTFE)	0 to 100°C (32°F to 212°F)



AODD/1-2/FPT/N	AODD/1-2/FPS/N	AODD/3-4/BAH/N	AODD/3-4/BPS/N	AODD/0-1/BAH/N
1/2"	1/2"	3/4"	3/4"	1"
Polypropylene	Polypropylene	Aluminium	Polypropylene	Aluminium
PTFE	Santoprene®	Hytrel®	Santoprene®	Hytrel®
0 - 45 LPM (0 - 11.90 GPM)	0 - 45 LPM (0 - 11.90 GPM)	0 - 110 LPM (0 - 29.1 GPM)	0 - 110 LPM (0 - 29.1 GPM)	0 - 110 LPM (0 - 29.1 GPM)
1/2"	1/2"	3/4"	3/4"	1"
3/8"	3/8"	3/4"	3/4"	3/4"
N/A	N/A	1/16" (2.0 mm)	1/16" (2.0 mm)	1/16" (2.0 mm)
8-feet	8-feet	18-feet	18-feet	18-feet
350 LPM (12.4 CFM)	350 LPM (12.4 CFM)	1200 LPM (42.4 CFM)	1200 LPM (42.4 CFM)	1200 LPM (42.4 CFM)
Polypropylene, PTFE	Polypropylene, PTFE	Aluminium, Stainless steel Hytrel®	Polypropylene, Santoprene®	Aluminium, Stainless steel, Hytrel®
PTFE (Flat type)	PTFE (Flat type)	Hytrel®	Santoprene®	Hytrel®
Ryton®	Ryton®	Aluminium	Glass-filled polypropylene	Aluminium
60°C (140°F)	60°C (140°F)	80°C (176°F)	60°C (140°F)	80°C (176°F)



Air Inlet Pressure
20-100 PSI (1.4 - 6.89 BAR)

CAT NR.	ORD NR.	SIZE	CASING	DIAPHRAGM	RECOMMENDED FLUIDS
AODD/1-4/FPT/N	44710	1/4"	Polypropylene	PTFE	Windshield washer fluid, Antifreeze, Caustic soda, Sulfuric acid (up to 75%), Plating Solution, Photograph developing liquid, Benzene, Hydrogen Peroxide, Waste water etc.
AODD/1-2/BAH/N	44720	1/2"	Aluminium	Hytrel®	Diesel fuel, Kerosene, Lubricants, Gear oil, Engine oil, Waste oil, Brake fluid, Naphtha, Mold lubricants, Antifreeze and Waste water
AODD/1-2/FPT/N	44721	1/2"	Polypropylene	PTFE	Windshield washer fluid, Antifreeze, Caustic soda, Sulfuric acid (up to 75%), Plating Solution, Photograph developing liquid, Benzene, Hydrogen Peroxide, Waste water etc.
AODD/1-2/FPS/N	44722	1/2"	Polypropylene	Santoprene®	AdBlue, Antifreeze, Ethanol, Ammonium hydroxide and Waste water
* AODD/3-4/BAH/N	44730	3/4"	Aluminium	Hytrel®	Diesel fuel, Kerosene, Lubricants, Gear oil, Engine oil, Waste oil, Brake fluid, Naphtha, Mold lubricants, Antifreeze and Waste water
AODD/3-4/BPS/N	44731	3/4"	Polypropylene	Santoprene®	AdBlue, Antifreeze, Ethanol, Ammonium hydroxide and Waste water
* AODD/0-1/BAH/N	44740	1"	Aluminium	Hytrel®	Diesel fuel, Kerosene, Lubricants, Gear oil, Engine oil, Waste oil, Brake fluid, Naphtha, Mold lubricants, Antifreeze and Waste water

Key * Best Seller

ELECTRIC OIL & FUEL PUMP



AUTOMOTIVE



AGRICULTURE



WORKSHOP



MARINE

Vertical mount Oil & Fuel pump designed for light Industrial, Automotive, Heating & Marine applications

For use with non flammable media

Pump has built-in bung adapter to fit directly onto drums with a 2" threaded opening

Manufactured from chemically inert materials; these pumps work with a wide variety of low viscosity media. Pump motor has double insulation which makes them safe for use with water & emulsions

Built-in anti-siphoning system ensures that media does not flow out by Siphon action incase of accidental damage to the delivery hose or dispensing nozzle

Duty Cycle: Continuous Duty

WETTED COMPONENTS

POM, Polypropylene, Stainless Steel, Nitrile Rubber, Viton & PTFE

RECOMMENDED USE

Diesel, Kerosene, Mineral & Synthetic Oils, Heating Oils, Antifreeze, Water, Emulsions etc. Pump can be used with Fluids with a maximum viscosity of 114 cst



CE

DRUM MOUNTING



! WARNING

DO NOT USE
With fluids with a flash point below 100°F (38°C), such as Gasoline & Alcohol

Sparking could result in explosion causing fatal injury

EOP

	EOP/AC/110	EOP/AC/230	EOP/DC/12	EOP/DC/24
Description	110V AC, 60 Hz	230V AC, 50 Hz	12V DC	24V DC
Flow rate	Upto 40 LPM (10.5 GPM)	Upto 40 LPM (10.5 GPM)	Upto 35 LPM (9.25 GPM)	Upto 35 LPM (9.25 GPM)
Motor	0.43 HP Centrifugal Motor	0.43 HP Centrifugal Motor	0.43 HP Centrifugal Motor	0.43 HP Centrifugal Motor
Amp	2.9 Amp	1 Amp	9.2 Amp	5.6 Amp
Absorbed Power	320 W	224 W	110 W	135 W
Internal Bypass Valve	No	No	No	No
Discharge Head	1 Meter	1 Meter	1 Meter	1 Meter
Suction Hose	¾" ID X 1m Long	¾" ID X 1m Long	¾" ID X 1m Long	¾" ID X 1m Long
Delivery Hose	¾" ID X 3m Long	¾" ID X 3m Long	¾" ID X 3m Long	¾" ID X 3m Long
Tank Adaptor	2" & M64 X 4	2" & M64 X 4	2" & M64 X 4	2" & M64 X 4
Inlet/Outlet	¾" Hose Barb	¾" Hose Barb	¾" Hose Barb	¾" Hose Barb
Dispensing Nozzle	Manual Polypropylene nozzle with ¾" Hose Barb	Manual Polypropylene nozzle with ¾" Hose Barb	Manual Polypropylene nozzle with ¾" Hose Barb	Manual Polypropylene nozzle with ¾" Hose Barb
Battery/Power Cable	2m long with plug	2m long with plug	3m long with battery clamps	3m long with battery clamps
Water/ Dust Protection	IPX-4 (protection against splashing water)	IPX-4 (protection against splashing water)	IPX-4 (protection against splashing water)	IPX-4 (protection against splashing water)
Noise Level	70 db	70 db	70 db	70 db

CAT NR.	ORD NR.	DESCRIPTION
EOP/AC/110	45522	110V AC
EOP/AC/230	45520	230V AC
EOP/DC/12	45521	12V DC
EOP/DC/24	45523	24V DC

FLOW RATE 

Upto 10.5 GPM (40 LPM)*

***measured at pump outlet tested using Diesel**

TEMPERATURE 

Working Temperature Range
-10°C to +40°C (14°F to 104°F)



AUTOMOTIVE



INDUSTRIAL



WORKSHOP

High pressure positive displacement meter suitable for in-line and end of line applications

Oval gear mechanism for optimum accuracy

6 Digit Non-Resettable Totaliser

Meter Inlet / Outlet threaded 1/2" (F)

Electronic Display using One 3V lithium Ion battery with life upto 5 years

Robust Aluminium Die Cast construction with protective shroud on meter

Protective shrouds available in a choice of colours – Black (Standard), Blue, Red, Green & Yellow for fluid identification

Display can be rotated in every 90° orientation for ease of installation

Measures in Litres, US Gallons, Quarts, Pints, Ounces & Decilitres

Easy user re-calibration

RECOMMENDED USE

Oils upto SAE 140, Diesel, Kerosene & Engine Coolants (RTU)

DO NOT USE WITH

Water based media, Gasoline etc.

WETTED COMPONENTS

Aluminum, Acetal, Nitrile Rubber & Steel

With 6 digit non-resettable totalizer



Note
Not to be used to measure media for resale

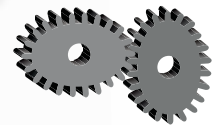

Oval Gear Mechanism

COLOR OPTION OF SHROUDS

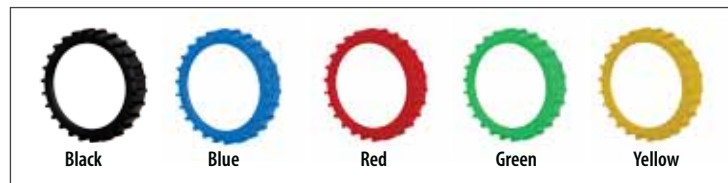

1,000 PSI (70 BAR)

FLOW RATE



1 to 30 LPM (0.3 to 8 GPM)

TEMPERATURE



-14°C to 55°C (7°F to 131°F)

ART. NR.	ORD. NR.	THREADS
OM-200/1-2/BSP	47000	1/2" BSP (F)
OM-200/1-2/N	47001	1/2" NPT (F)

Flow rate	1 to 30 LPM (0.3 to 8 GPM)
Accuracy	+ / - 0.50%
Repeatability	0.20 %
Max. Working Pressure	1000 PSI (70 BAR)
Pressure Loss	10 PSI (0.7 BAR)
Working Temperature range	-14°C to 55°C (7°F to 131°F)
Max. Resettable Batch Total	99,999.9 units
Max. Non Resettable Totalizer	9,99,999 units
Least Count /Resolution	Upto 0.001 units
Display Output	User Selectable for 0.1, 0.01, 0.001 units
Water Resistance	IP65

FOUR DISPLAY ROTATION



95

MECHANICAL OIL METERS

NEW!

OM-100



AUTOMOTIVE



INDUSTRIAL



WORKSHOP

High pressure positive displacement meter suitable for in-line and end of line applications

Oval gear mechanism for optimum accuracy

7 Digit Non-Resetable Totaliser

Meter Inlet / Outlet threaded 1/2" (F) for use with Air / Electric / Manual pumps

High reliability Mechanical Display

Robust Aluminum Die Cast construction with protective shroud on meter

Protective shrouds available in a choice of colours – Black (Standard), Blue, Red, Green & Yellow. Help in fluid identification

Available in Litres / Quarts version

RECOMMENDED USE

Oils upto SAE 140, Diesel, Kerosene & Engine Coolants (RTU)

DO NOT USE WITH

Water based media, Gasoline etc.

WETTED COMPONENTS

Aluminum, Acetal, Nitrile Rubber & Steel

With 7 digit non-resetable totalizer



Note
Not to be used to measure media for resale

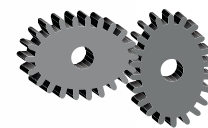

Oval Gear Mechanism

COLOR OPTION OF SHROUDS

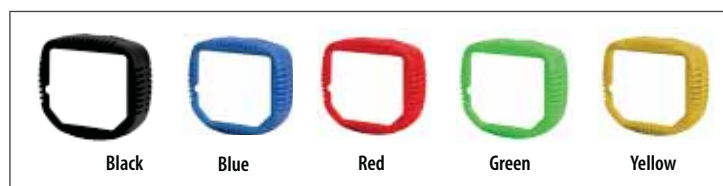

1,000 PSI (70 BAR)

FLOW RATE



1 to 30 LPM (0.3 to 8 GPM)

TEMPERATURE



-10°C to 55°C (14°F to 131°F)

Flow rate	1 to 30 LPM (0.3 to 8 GPM)
Accuracy	+ / - 1%
Repeatability	0.30%
Max. Working Pressure	1000 PSI (70 BAR)
Pressure Loss	10 PSI (0.7 BAR)
Working Temperature range	-10°C to 55°C (14°F to 131°F)
Max. Resetable Batch Total	999.9 Litres or Quarts
Max. Non Resetable Totalizer	999999.9 Litres or Quarts
Least Count /Resolution	0.10 Litres or Quarts
Water Resistance	IP55

CAT. NR.	ORD NR.	MEASUREMENT	THREADS
OM-100/1-2/BSP	47050	Litres	1/2" BSP (F)
OM-100/1-2/N	47051	Litres	1/2" NPT (F)
OM-100Q/1-2/N	47052	Quarts	1/2" NPT (F)

96

ELECTRONIC OIL CONTROL GUNS

NEW!

OM200-OG



AUTOMOTIVE



WORKSHOP

Super accuracy heavy duty gun for controlling fluid deliveries in most demanding applications

Oval gear mechanism

Electronic Display using one 3V Lithium Ion battery with life upto 5 years

Aluminium Die cast meter & gun body

Protective shroud on meter. Protective shrouds available in a choice of colours – Black (Standard), Blue, Red, green & yellow for fluid identification

Built-in continuous Flow switch can be activated for un-attended dispensing

Built In swivel at inlet for easy maneuverability

Measures in Litres, US Gallons, Quarts, Pints, Ounces & Decilitres

Easy user re calibration

Supplied complete with rigid steel or flex hose fitted with curved steel extension, with a choice of manual & automatic non drip nozzles

RECOMMENDED USE

Oils with viscosity upto SAE 140, Diesel, Kerosene & Engine Coolants (RTU)

DO NOT USE WITH

Water based media, Gasoline etc.

WETTED COMPONENTS

Aluminum, Acetal, Nitrile Rubber & Steel



1,000 PSI (70 BAR)

Flow rate	1 to 30 LPM (0.3 to 8 GPM)
Accuracy	+ / - 0.50%
Repeatability	0.20 %
Max. Working Pressure	1000 PSI (70 BAR)
Working Temperature range	-14°C to 55°C (7°F to 131°F)
Max. Resettable Batch Total	99,999.9 units
Max. Non Resettable Totalizer	9,99,999 units
Least Count /Resolution	Upto 0.001 units
Display Output	User Selectable for 0.1, 0.01, 0.001 units
Inlet threaded	½" BSPT (F) / ½" NPT (F)
Water Resistance	IP55

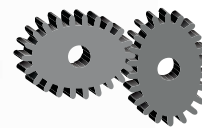

Oval Gear Mechanism

FLOW RATE



1 to 30 LPM (0.3 to 8 GPM)

TEMPERATURE



-14°C to 55°C (7°F to 131°F)



Flex Bent - Auto



Flex Bent - Manual



Rigid - Manual

CAT NR.	ORD. NR.	CAT NR.	ORD. NR.	EXTENSION	NON DRIP NOZZLE
BSPT THREADS		NPT THREADS			
OM-200/OG/FB-M/B	47481	OM-200/OG/FB-M/N	47421	Flexible with Bent Steel	Manual
OM-200/OG/FB-A/B	47480	OM-200/OG/FB-A/N	47420	Flexible with Bent Steel	Automatic
OM-200/OG/R-M/B	47482	OM-200/OG/R-M/N	47422	Rigid Steel	Manual
OM-200/OG/R-A/B	47483	OM-200/OG/R-A/N	47423	Rigid Steel	Automatic

Note
Not to be used to measure media for resale

97

MECHANICAL OIL CONTROL GUNS

NEW!

OM100-OG



AUTOMOTIVE



WORKSHOP

Super accuracy heavy duty gun for controlling fluid deliveries in most demanding applications

Oval gear mechanism

High Reliability Mechanical display

Aluminium Die cast meter & gun body

Protective shroud on meter. Protective shrouds available in a choice of colours – Black (Standard), Blue, Red, green & yellow for fluid identification

Built-in continuous Flow switch can be activated for un-attended dispensing

Built In swivel at inlet for easy maneuverability

Available in Litre / Quart version

Supplied complete with rigid steel or flex hose fitted with curved steel extension, with a choice of manual & automatic non drip nozzles

RECOMMENDED USE

Oils with viscosity upto SAE 140, Diesel, Kerosene & Engine Coolants (RTU)

DO NOT USE WITH

Water based media, Gasoline etc.

WETTED COMPONENTS

Aluminum, Acetal, Nitrile Rubber & Steel



1,000 PSI (70 BAR)



Flow rate	1 to 30 LPM (0.3 to 8 GPM)
Accuracy	+ / - 1%
Repeatability	0.30%
Max. Working Pressure	1000 PSI (70 BAR)
Pressure Loss	10 PSI (0.7 BAR)
Working Temperature range	-10°C to 55°C (14°F to 131°F)
Max. Resettable Batch Total	999.9 Litres or Quarts
Max. Non Resettable Totalizer	999999.9 Litres or Quarts (7 Digit)
Least Count /Resolution	0.10 Litres or Quarts
Inlet threaded	½" BSPT (F) / ½" NPT (F)
Water Resistance	IP55

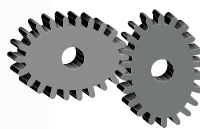

Oval Gear Mechanism

FLOW RATE



1 to 30 LPM (0.3 to 8 GPM)

TEMPERATURE



-10°C to 55°C (14°F to 131°F)



CAT NR.	ORD.NR.	CAT NR.	ORD.NR.	MEASUREMENT	EXTENSION	NON DRIP NOZZLE
BSPT THREADS		NPT THREADS				
OM-100/OG/FB-M/B	47460	OM-100/OG/FB-M/N	47410	Litres	Flexible with Bent Steel	Manual
OM-100/OG/FB-A/B	47461	OM-100/OG/FB-A/N	47411	Litres	Flexible with Bent Steel	Automatic
OM-100/OG/R-M/B	47462	OM-100/OG/R-M/N	47412	Litres	Rigid Steel	Manual
OM-100/OG/R-A/B	47463	OM-100/OG/R-A/N	47413	Litres	Rigid Steel	Automatic
----	----	OM-100Q/OG/FB-M/N	47401	Quart	Flexible with Bent Steel	Manual
----	----	OM-100Q/OG/FB-A/N	47400	Quart	Flexible with Bent Steel	Automatic
----	----	OM-100Q/OG/R-M/N	47402	Quart	Rigid Steel	Manual
----	----	OM-100Q/OG/R-A/N	47403	Quart	Rigid Steel	Automatic

Note
Not to be used to measure media for resale

98

ELECTRONIC PRESET OIL CONTROL GUN

NEW!

OM-300



AUTOMOTIVE



INDUSTRIAL

Heavy Duty Oil Control gun with Robust Aluminium Construction

Electronic Preset design, works on 4 x 1.5V AA Batteries

Dual Mode: Manual & Pre Set (dispenses set qty. of media & stops)

Oval Gear Mechanism for Optimum accuracy

Adjustable Outlet nozzle can be positioned for in-line or 90° dispensing

Resettable Totalizer for Individual Batch can be set in Litres, Quarts, Pints & Gallons

A second Resettable Totalizer for multiple dispense operations can be set in Litres, Quarts, Pints & Gallons with a Max. Pre Set volume of 99.9 units

Lifetime Non-Resettable Totalizer can be set in Litres or Gallons

Built in Swivel at Inlet fitted with strainer

Supplied complete with Steel Extension with Built-in non drip tip

WETTED COMPONENTS
Aluminium, Steel, Stainless Steel, Brass, Polyurethane, Acetic Resin, Hi Nitrile Rubber

RECOMMENDED USE
Oils with viscosity in the range of 10 to 5000 cst, Diesel

DO NOT USE
Gasoline, Antifreeze, Windshield Fluids etc.

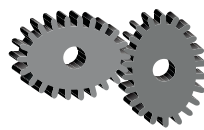

Oval Gear Mechanism



Maximum Pressure 1000 PSI (69 BAR)

Non Drip Tip

Steel Extension

LCD display

Shock resistant handle

1/2" Swivel with in-built strainer

Flow Rate	1 to 30 LPM (0.3 to 8 GPM)
Inlet	1/2" BSP (F) / 1/2" NPT (F)
Accuracy	+/- 0.50%
Repeatability	+/- 0.20%
Max. Working Pressure	1000 PSI (69 BAR)
Working Temperature range	-5°C to 50°C (23°F to 122°F)
Measuring Units	Litres, Quarts, Pints, Gallons
Minimum Pre Set Qty.	0.10 Units
Maximum Pre Set Qty.	99.9 Units
Max. Resettable Batch Total	999.9 Units
Max. Non Resettable Totalizer	999999 Units
Viscosity of Media Dispensed	10 to 5000 cst
Resolution / Least Count	0.005 Litre / 0.0013 Gallon
Water Resistance	IP55

Note: Not to be used to measure media for resale

CAT. NR.	ORD. NR.	INLET THREADS
OM/300/PS/RA/BSP	45722	1/2" BSP (F)
OM/300/PS/RA/N	45721	1/2" NPT (F)

FLOW RATE

1 to 30 LPM (0.3 to 8 GPM)

TEMPERATURE

-5°C to 50°C (23°C to 122°F)

99

OIL CONTROL GUNS

OGY



AUTOMOTIVE



INDUSTRIAL



WORKSHOP

Oil Gun with
Steel ExtensionOil Gun with Steel Extension
& Manual Non Drip NozzleOil Gun with Hose &
Manual Non Drip Nozzle

For use with Air Operated Oil Pumps upto 6:1 Pressure ratio

Gun dispenses by simple press of the trigger

In-built safety lever; can be locked in two positions

- Slide over the trigger & lock, enabling continuous dispensing
- Slide under the trigger & lock, preventing accidental dispensing

Slim construction of the steel outlet spout allows the gun to be used to fill small openings
Built-in swivel threaded at inlet for easy maneuverability

Standard configuration includes steel outlet extension & available as Gun Only or Gun with manual non drip nozzle

Also available gun fitted with hose and manual non drip nozzle

RECOMMENDED USE

Oil, Gear Lube, ATF

DO NOT USE WITH

Water based media, Gasoline etc.

WETTED COMPONENTS

Steel, Nylon, Stainless Steel, Viton, Nitrile Rubber*

* on models with hose/non drip nozzle

In-Line Swivel	½" (F)
Outlet Diameter of Steel Spout	½" (12.7 mm)
Inside Diameter of Hose Extension	½" (12.7 mm)
Max. Inlet Pressure	870 PSI (60 BAR)
Max. Flow rate	70 LPM (18.5 GPM)
Working Temperature Range	-10°C to 60°(14°F to 140°F)



Maximum Pressure
870 PSI (60 BAR)

FLOW RATE

Upto 70 LPM (18.5 GPM)

TEMPERATURE

Working Temperature Range
-10°C to 60°C (14°F to 140°F)

CAT. NR.	ORD. NR.	CAT. NR.	ORD. NR.	INLET THREADS
WITH STEEL EXTENSION		WITH HOSE EXTENSION		
GUN ONLY				
OGY/S/1-2R/B	45715	---	---	1/2" BSPT (F)
OGY/S/1-2R/N	45716	---	---	1/2" NPT (F)
GUN WITH MANUAL NON DRIP NOZZLE				
OGY/SM/1-2R/B	45717	OGY/SM/1-2F/B	45730	1/2" BSPT (F)
OGY/SM/1-2R/N	45718	OGY/SM/1-2F/N	45731	1/2" NPT (F)

100

OIL CONTROL GUN ACCESSORIES

Non Drip Nozzles

Commonly used with oil control valves / hose end guns. Used either with steel extensions or hoses at discharge end to cut off media supply, once the filling is complete. Steel construction with nitrile rubber seals. Available in 2 models

Manual Non Drip Nozzle

Can be operated by manually rotating the body. Both opening & shutting off the nozzle are manual. These provide minimal pressure drop and are ideal for high flow applications



CAT. NR.	ORD. NR.	TIP DIA.	INLET THREADS
NDN/26/1-4F/B	45035	0.59" (15 mm)	1/4" BSPT (F)
NDN/26/1-4F/N	45034	0.59" (15 mm)	1/4" NPT(F)

Automatic Non Drip Nozzle

Designed with multiple check valves to achieve absolute non-drip. The nozzle opens automatically under fluid pressure; and shuts off automatically with the release of pressure. The discharge end has a narrow section allowing the nozzle to dispense into small openings



CAT. NR.	ORD. NR.	TIP DIA.	INLET THREADS
NDN/02/1-4F/B	45010	5/8" (16 mm)	1/4" BSPT (F)
NDN/02/1-4F/N	45012	5/8" (16 mm)	1/4" NPT(F)

Oil Gun Hose Extension

Flexible Oil Hose Extension for use with Oil Control Guns

Max. Working Pressure
2,320 PSI (160 BAR)

Overall Length
8" (200 mm)

Hose Inner Dia.
1/2" (12.7 mm)

Fittings
1/2" (M) x 1/4" (M)

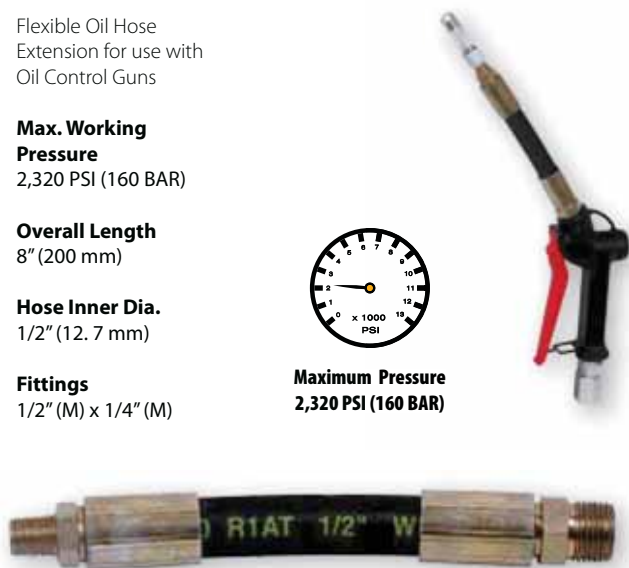

CAT. NR.	ORD. NR.	THREAD 1	THREAD 2
SA/HOS/OGY/BSP	43895	1/2" BSP (M)	1/4" BSPT (M)
SA/HOS/OGY/N	43896	1/2" NPT (M)	1/4" NPT(M)

Oil Meter Swivel

Swivel Adaptor for Oil Meters / Hose End Guns

Large 1/2" (13 mm) inner dia. for least resistance to flow

Steel construction with bright zinc plated finish

Threaded
1/2" (M) x 1/2" (F)



CAT. NR.	ORD. NR.	THREADS
SWV/1-2M/1-2F/B	43891	1/2" BSPT (M) X 1/2" BSPT (F)
SWV/1-2M/1-2F/N	43890	1/2" NPT (M) X 1.2" NPT (F)

101

OIL SPIGOTS

Professional Grade Spigots, used as a dispenser with Air Operated Pumps, as well as to construct Oil bars.

Spring Loaded dispensing mechanism

CNC machined for non drip operation

Available in both Locking & non Locking styles in a choice of materials – Steel or Aluminium / SS combination

OBT-01

- Steel Body in Nickel Chrome Plated Finish
- Includes Wall Mount Attachment
- Locking Style
- Available with Nitrile or Viton Seals

OBT-02

- Steel Body in Nickel Chrome Plated Finish
- Without Wall Mount Attachment
- Locking Style
- Available with Nitrile or Viton Seals

OBT-03

- Steel Body in Nickel Chrome Plated Finish
- Includes Wall Mount Attachment
- Non-Locking Style
- Available with Nitrile or Viton Seals

OBT-03WF

- Aluminium Body with Stainless Steel Internal parts
- Includes Wall Mount Attachment
- Non-Locking Style
- Viton Seals



OBT-01



OBT-02



800 PSI
(55 BAR)

CAT. NR.	ORD. NR.	CAT. NR.	ORD. NR.	TYPE	SEALS	THREADS	BODY MATERIAL
BSP THREADS		NPT THREADS					
OBT/01	44350	OBT/01/N	47800	Locking	Nitrile	3/4" (M)	Steel
OBT/01V	44352	OBT/01V/N	47801	Locking	Viton	3/4" (M)	Steel
OBT/02	44351			Locking	Nitrile	3/4" (F)	Steel
OBT/02V	44353			Locking	Viton	1/2" (F)	Steel
◆ OBT/03	47802	OBT/03/N	47803	Non-Locking	Nitrile	3/4" (M)	Steel
◆ OBT/03/WF	47804	OBT/03/WF/N	47805	Non-Locking	Viton	3/4" (M)	Aluminium & SS

Key ◆ New

SG-10

SG-10CL

NEW!

SG-11

SG-11XL

NEW!

A rugged transfer gun designed for use with gear oils to get them both into and out of gear boxes, transfer cases and differentials

Deluxe lip seal provides maximum suction

Steel Barrel in premium powder coated finish

Fully serviceable

Needs no priming

Suitable for use with non corrosive liquids

Available in a choice of 2 size - 500ml (16oz.) & 700 ml (24 oz.)

SG-11

Plated Steel Head

Complete with 12" (300 mm) flexible Vinyl Hose

Also available as spare:

HOSE/SG/10/12

SG-10

Aluminum Die Cast Head

SG-11XL

Plated Steel Head

Also available with **Clear Tube Barrel**

Clear Grease Guns provide quick lubricant identification eliminating the risk of mixing incompatible or unspecified lubricants. This makes them the perfect choice for food industry, army etc.

CAT. NR.	ORD. NR.	CAPACITY
SG/10-BL	45200	500 ml (16 oz.)
* SG/11-BL	45205	500 ml (16 oz.)
◆ SG/11/XL	45220	700 ml (24 oz.)
SUCTION GUN - CLEAR TUBE		
◆ SG/10/BL-CL	46940	500 ml (16 oz.)
HOSE/SG/10/12	44342	----

Key * Best Seller ◆ New

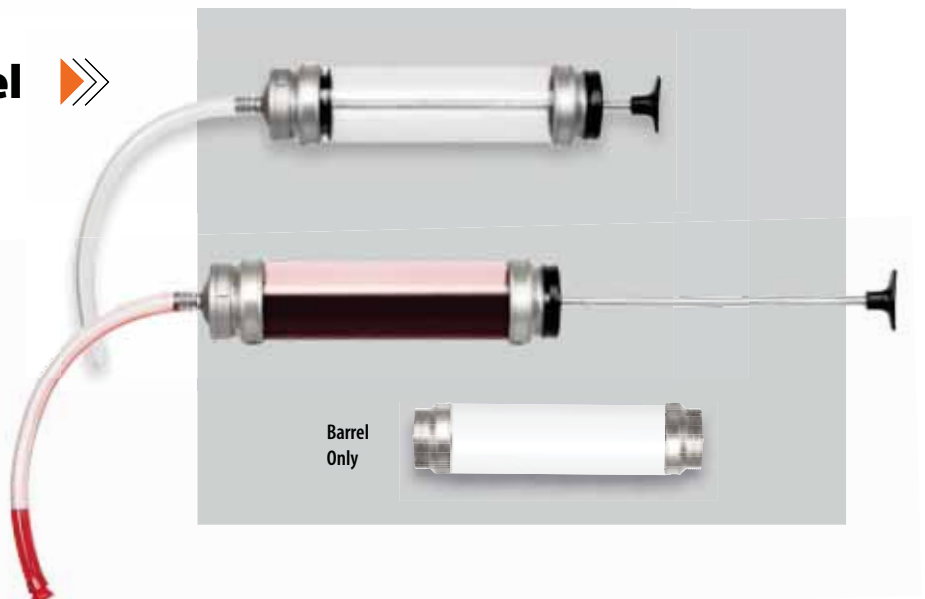

103

TRANSFER GUN

SG-20

Dual Direction Transfer Gun: Draws in & pumps out liquid in a single stroke

Easy & safe answer to fluid transfer, especially useful in transferring media unsafe for body contact

Gun body is non-denting & is made from heavy aluminum section. Suction Head & piston have an aluminum construction & use Viton piston rings

The gun comes complete with 8' of vinyl hose (4' with each valve)

WETTED COMPONENTS

Aluminum, Brass, Viton, PVC

RECOMMENDED USE

Fuel oils, Mineral oils, Synthetic & Biological oils, Petrol, Cooling liquids, Water, Antifreeze, Spirits & Brake fluids



Complete with 8' of Vinyl Hose (4' with each valve).

HOSE/SG/20/96

Also available as spare

CAT. NR.	ORD. NR.	CAPACITY
SG/20	45250	350 ml (12 oz.)
HOSE/SG/20/96	44343	

Complete range of oil dispensing cans in a range of sizes from 125 ml to 1 litre (4 oz. to 1 quart)

All steel construction, with the body seamless drawn from tin coated sheet in premium powder coated finish

Metal pump has 2 ball valves for large volume delivery per stroke. The suction valve at the bottom of pump is without spring, which prevents malfunctioning because of sticking valve due to resinous oil

PT Series

The PT series Oil cans have a modern & contemporary design with a dome shaped body. This is the most popular oil can design worldwide. Both types of oil cans are manufactured with
a. Steel Pump - Powder coated Red
b. Brass Pump - Powder coated Blue

Can be supplied with rigid steel extension, wire braided flexible spout or both



CAT. NR.	ORD. NR.	CAT. NR.	ORD. NR.	CAT. NR.	ORD. NR.	CAPACITY	SPOUT LENGTH	
RIGID SPOUT		FLEXIBLE SPOUT		RIGID & FLEXIBLE SPOUT			RIGID	FLEXIBLE
PT SERIES - LEVER TYPE - STEEL PUMP								
MP21R	41410	MP21F	41420	MP21R/F	41430	200 ml / 6 oz.	5" (125 mm)	6" (150 mm)
MP22R	41411	MP22F	41421	MP22R/F	41431	300 ml / 10 oz.	5" (125 mm)	6" (150 mm)
MP22/4R	41412	MP22/4F	41422	MP22/4R/F	41432	400 ml / 13 oz.	6" (150 mm)	7" (175 mm)
MP23R	41413	MP23F	41423	MP23R/F	41433	500 ml / 16 oz / 1 pint	6" (150 mm)	7" (175 mm)
MP24R	41414	MP24F	41424	MP24R/F	41434	700 ml / 23 oz.	7" (175 mm)	8" (200 mm)
MP25R	41415	MP25F	41425	MP25R/F	41435	1000 ml / 1 quart	8" (200 mm)	9" (225 mm)
PT SERIES - LEVER TYPE - BRASS PUMP								
MP21RB	41610	MP21FB	41620	MP21R/FB	41630	200 ml / 6 oz.	5" (125 mm)	6" (150 mm)
MP22RB	41611	MP22FB	41621	MP22R/FB	41631	300 ml / 10 oz.	5" (125 mm)	6" (150 mm)
MP22/4RB	41612	MP22/4FB	41622	MP22/4R/FB	41632	400 ml / 13 oz.	6" (150 mm)	7" (175 mm)
MP23RB	41613	MP23FB	41623	MP23R/FB	41633	500 ml / 16 oz / 1 pint	6" (150 mm)	7" (175 mm)
MP24RB	41614	MP24FB	41624	MP24R/FB	41634	700 ml / 23 oz.	7" (175 mm)	8" (200 mm)
MP25RB	41615	MP25FB	41625	MP25R/FB	41635	1000ml / 1 quart	8" (200 mm)	9" (225 mm)
PT Series - Pistol Grip								
STEEL								
M10R	42220	M10F	42225	M10R/F	42230	125 ml / 4 oz.	4" (100 mm)	5" (125 mm)
M15R	42221	M15F	42226	M15R/F	42231	180 ml / 6 oz.	4" (100 mm)	5" (125 mm)
M15R/BS with base	42222	M15F/BS with base	42227	M15R/F/BS with base	42232	180 ml / 6 oz.	4" (100 mm)	5" (125 mm)
M40R	42223	M40F	42228	M40R/F	42233	500 ml / 16 oz. / 1pint	6" (150 mm)	7" (175 mm)
BRASS PUMP								
M10RB	42240	M10FB	42245	M10RB/F	42250	125 ml / 4 oz.	4" (100 mm)	5" (125 mm)
M15RB	42241	M15FB	42246	M15RB/F	42251	180 ml / 6 oz.	4" (100 mm)	5" (125 mm)
M15RB/BS with base	42242	M15FB/BS with base	42247	M15RB/F/BS with base	42252	180 ml / 6 oz.	4" (100 mm)	5" (125 mm)
M40RB	42243	M40FB	42248	M40RB/F	42253	500 ml / 16 oz. / 1pint	6" (150 mm)	7" (175 mm)

PT Series

OC Series

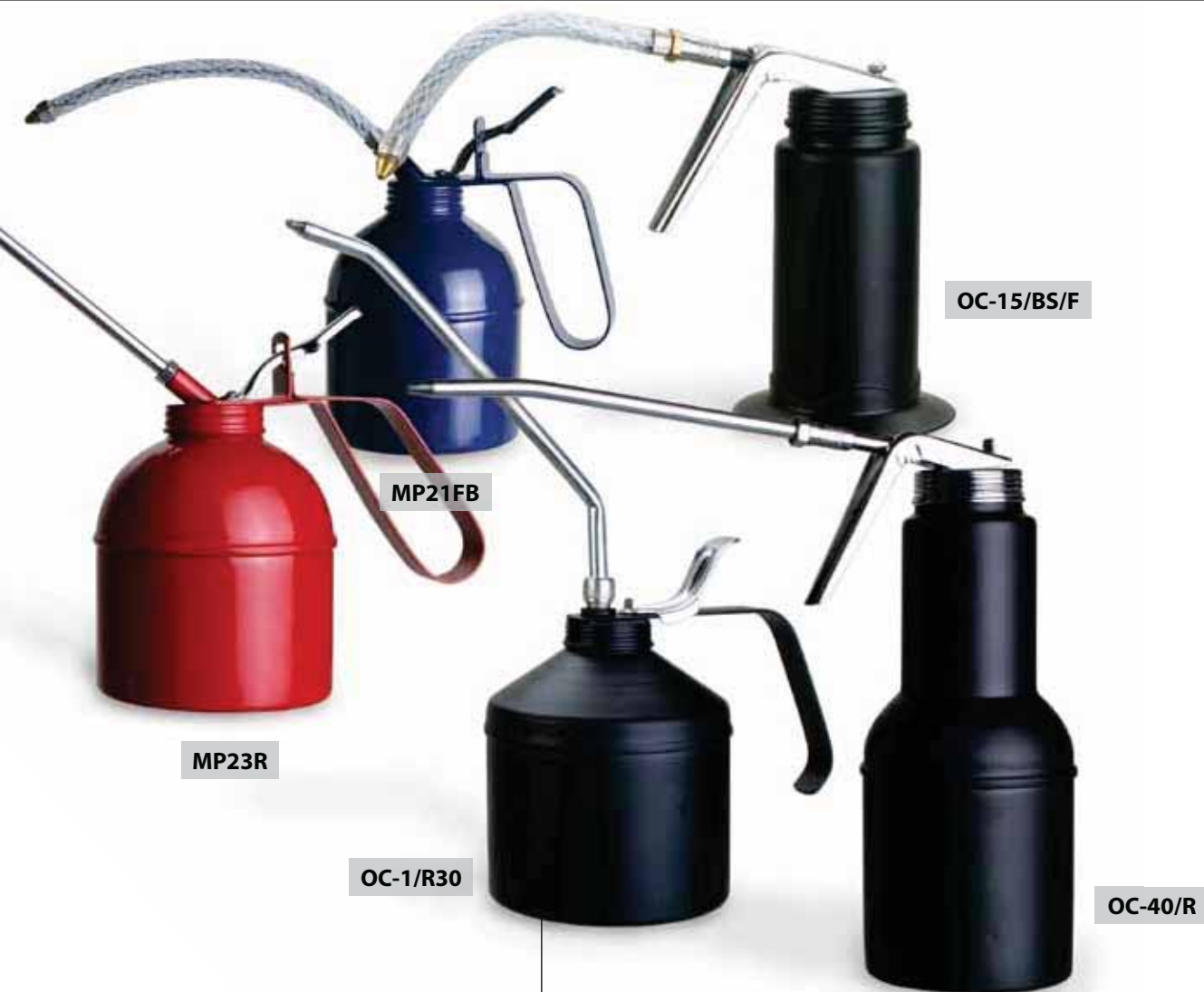

OC Series

The OC series Oil cans have a more traditional design. These are designed for large hands & are popular in North America. Available both in Lever & Pistol style, these have a steel pump construction & have a premium powder coated finish. Lever style Oil Cans come with a choice of rigid steel spouts with 30° bent or wire braided flexible spouts. Pistol style are supplied with either rigid steel or wire braided flexible extension

CAT. NR.	ORD. NR.	CAT. NR.	ORD. NR.	CAPACITY	SPOUT LENGTH	
LEVER TYPE WITH 30° ANGLED RIGID SPOUT		LEVER TYPE WITH FLWXIBLE SPOUT			RIGID	FLEXIBLE
OC-1/R30	41810	OC-1/F	41815	500 ml / 1 pint	9" (225 mm)	9" (225 mm)
OC-2/R30	41811	OC-2/F	41816	1000 ML / 1 QUART	9" (225 mm)	9" (225 mm)
PISTOL TYPE WITH RIGID SPOUT		PISTOL TYPE WITH FLEXIBLE SPOUT				
OC-15/BS/R	41820	OC-15/BS/F	41825	180 ml / 6 oz.	6" (150 mm)	6" (150 mm)
OC-40/R	41821	OC-40/F	41826	500 ml / 1 pint	6" (150 mm)	6" (150 mm)

105

SPECIALITY OIL CANS



Unbreakable & rust resistant plastic body Oil Cans with graduations marked on the bottle in both ml & oz.

Oil discharge is through the "squeeze-action" of the oil can bottle. Comes complete with telescopic steel tube with plastic nut & non drip tip

CAT. NR.	ORD. NR.	CAPACITY	SPOUT LENGTH
SQUEEZ-IT-PLASTIC OIL CAN			
SQZ/01	41801	215 ml (8 oz.)	9" (230 mm)
SQZ/02	41802	215 ml (8 oz.)	6" (150 mm)

106

FLEXIBLE & RIGID SPOUTS

Oil can discharge spouts - rigid or flexible are fully interchangeable and available as spares in different lengths

Spouts are threaded 1/4" UNEF X 32 TPI



CAT. NR.	ORD. NR.	LENGTH END TO END	
		Inch	mm
FLEXIBLE SPOUT			
FS-5	41205	5	125
FS-6	41206	6	150
FS-7	41207	7	175
FS-8	41208	8	200
FS-9	41209	9	225
RIGID SPOUT			
RS-4	41224	4	100
RS-5	41225	5	125
RS-6	41226	6	150
RS-7	41227	7	175
RS-9	41229	9	225

FS

Wire braided PVC construction, with solid brass ends. The ends are male threaded & can be easily screwed onto the female threaded spout on the oil can. These are especially useful for oiling hard to reach areas

RS

Rigid spouts are made from zinc plated steel, with a slight bent at the discharge end. The ends are male threaded and can be easily screwed onto the female threaded spout on the oil can

For GROZ
PT Series
Oil Cans

107

FLEXIBLE SPOUT MEASURES

Plastic Measures have a translucent high density Polyethylene construction & are used for transferring metered qty. of fluids

These are marked in both Litres & Quarts

Supplied with Polyethylene flexible spout with cap and polypropylene lid

Flexible spouts available as spare

Note

Measures must not be used to measure media for sale / commercial use

Other color options can be custom built



CAT. NR.	ORD. NR.	CAPACITY
* MSR/P/F-1	41900	1 litre (1 quart)
MSR/P/F-2	41901	2 litre (2 quart)
MSR/P/F-3	41902	3 litre (3 quart)
* MSR/P/F-5	41903	5 litre (5 quart)
◆ MSR/P/F-6	41904	6 litre (6 quart)

Key * Best Seller ◆ New

FNL-8

FNL-9

Heavy Duty Polypropylene construction

Designed with special contours in the funnel body for easy handling

Anti-Splash & Spill Proof, with rim of the funnel curved in
Complete with Wire Mesh Screen, Dust Cover & flexible spout

Available in 2 sizes. The larger size is available both with and without drum bung attachment, which allows the funnel to be mounted direct onto drums with 2" threaded opening

Manufactured in translucent white to give a clear view of media

Other color options can be custom built on request



FNL/9B

Capacity
3.0 Litre (3 QT.)
Dia
9-1/2" (240 mm)



Connects directly to drums with 2" opening



FNL-9

Capacity
3.0 Litre (3 QT.)
Dia
9-1/2" (240 mm)



FNL-8

Capacity
1.7 Litre (1.7 QT.)
Dia
8" (205 mm)

Spill proof funnel design



Curved funnels ends make it splash proof

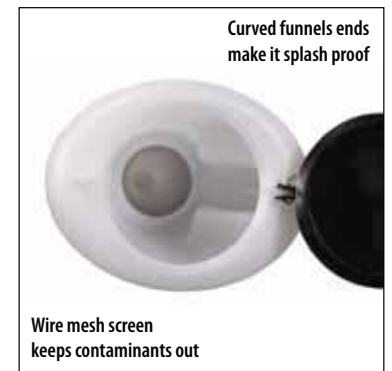

Wire mesh screen keeps contaminants out

CAT. NR.	ORD. NR.	CAPACITY	MAJOR DIA.	SPOUT LENGTH
* FNL/8	41920	1.7 litre (1.7 quart)	8" (205 mm)	6-11/16" (170 mm)
FNL/9	41921	3 litre (3 quart)	9-1/2" (240 mm)	9-5/8" (245 mm)
* FNL/9B	41922	3 litre (3 quart)	9-1/2" (240 mm)	9-5/8" (245 mm)

Key * Best Seller



118



118



118

HOSE

reels

Smart Solutions for 'reel' challenges
in the most demanding conditions -
Groz Hose Reels are engineered for
exceptional performance

NEW PRODUCTS to look out for

118 AIR WATER -LOW PRESSURE HOSE REELS

118 OIL - MEDIUM PRESSURE HOSE REELS

118 GREASE - HIGH PRESSURE HOSE REELS



AUTOMOTIVE



INDUSTRIAL

All metal construction with a ribbed steel disk that prevents bending & flexing. Rolled edges for added strength & stability

Compact design allows these to be used in confined spaces with ease

Casseted Spring Design: Drive springs are manufactured from highest quality spring steel that ensures long life. Precise manufacturing guarantees a superior quality edge. Fully enclosed cassetted design makes the spring resistant to corrosion caused by water & dirt, guaranteeing longer life & trouble free operation. Further this design makes it easy & safe for maintenance.

Ratchet: Heavy duty dual ratchet reduces stress on spring providing smooth & balanced operation during hose extension & retraction. Dual ratchet teeth can lock hose in multiple usable positions

Multiple Position Guide Arm: Guide arms can be adjusted at 45° intervals that provides versatile floor, wall or truck mounting with a convenient mounting angle for hose to be released at optimum position

Reels are available with two options of Guide Arms: Dual guide arm option for Medium & high pressure applications involving grease & oils. Dual guide arm design is structurally reinforced strengthened with metal ribs that prevent flexing and bending due to hose pull. Single guide arm option for low pressure applications involving air and water

Adjustable roller guide arm with removable nylon guide rollers reduces drag & wear

Inlet swivel reduces torque load on power spring for smoother hose movement & durability

1/4" (6.35mm) thick steel base with easy mounting eyelet hole

All components are electrostatically powder coated after cleaning, degreasing & iron phosphate penetrating ensuring a long lasting, durable & attractive finish.

Hose reels come with an option of 10 mtr (32.8') & 15 mtr (49.2') hose

Hose Reel accessories for floor mounting & angular mounting on walls are also available

Nylon guide rollers reduce drag & wear

Rolled edges resist bending

Ribbed Steel disk for maximum strength

Adjustable hose stopper allows any desired length of hose to be maintained outside the reel

Casseted power spring protects spring from corrosion against water & dirt and offers increased safety during repair / maintenance

1/4" (6.35 mm) thick steel base for added stability

8 position guide arm for convenient mounting on any surface

**AIR / WATER
LOW
PRESSURE
HOSE REELS**

Multi position ratchet locks hose at any desired length

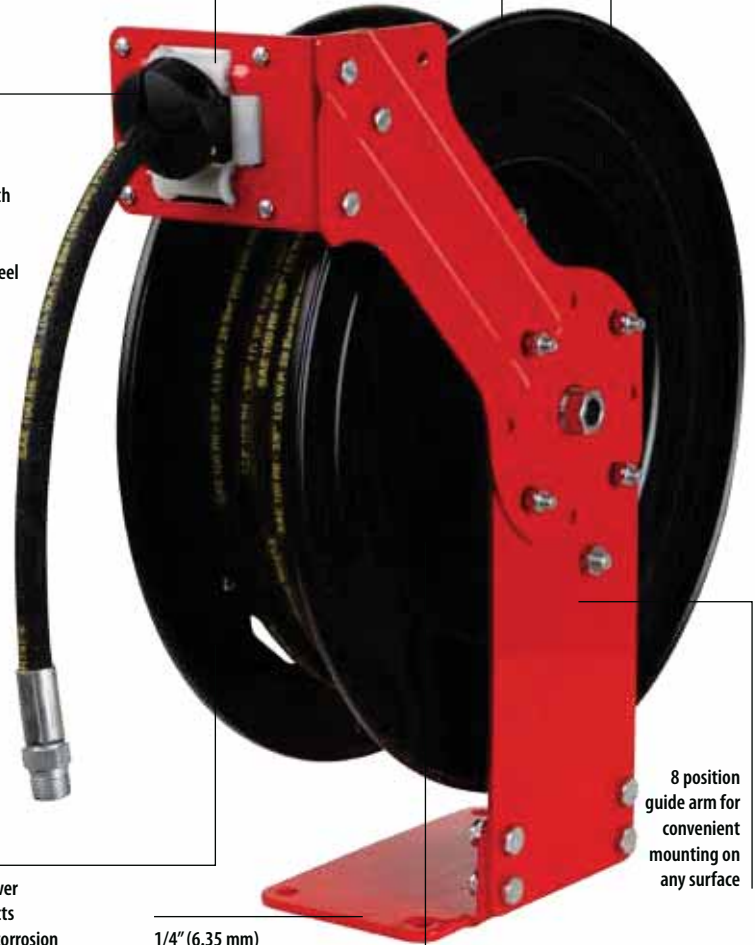

NEW!

HR-AW

NEW!

HR-OL

NEW!

HR-GR



**OIL
MEDIUM
PRESSURE
HOSE REELS**



**GREASE
HIGH
PRESSURE
HOSE REELS**

Hose Reel Bolt Pattern

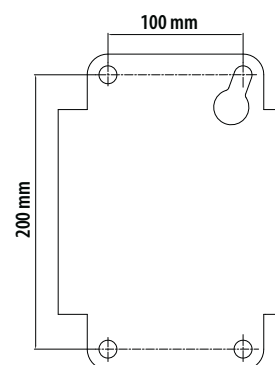

HOSE REELS



SWV/HR/360

47950

Floor Mounting Bracket
(available as spare)



SWV/HR/140

47951

Wall Mounting Bracket
(available as spare)



CAT. NR.	ORD. NR.	CAT. NR.	ORD. NR.	MAX. PRESSURE	INLET / OUTLET THREADS	HOSE ID	HOSE OD	HOSE LENGTH
BSPT		NPT						
AIR WATER - LOW PRESSURE HOSE REELS								
HR/AW/10M/3-8/B	47900	HR/AW/10M/3-8/N	47920	300 PSI (21 BAR)	3/8"	3/8"(9.5mm)	5/8"(15.9mm)	10 m (32.8')
HR/AW/15M/3-8/B	47901	HR/AW/15M/3-8/N	47921	300 PSI (21 BAR)	3/8"	3/8"(9.5mm)	5/8"(15.9mm)	15 m (49.2')
HR/AW/10M/1-2/B	47902	HR/AW/10M/1-2/N	47922	300 PSI (21 BAR)	1/2"	1/2"(12.7mm)	3/4"(19mm)	10 m (32.8')
HR/AW/15M/1-2/B	47903	HR/AW/15M/1-2/N	47923	300 PSI (21 BAR)	1/2"	1/2"(12.7mm)	3/4"(19mm)	15 m (49.2')
OIL - MEDIUM PRESSURE HOSE REELS								
HR/OL/10M/3-8/B	47960	HR/OL/10M/3-8/N	47970	2000 PSI (138 BAR)	3/8"	3/8"(9.5mm)	23/32"(18.1mm)	10 m (32.8')
HR/OL/10M/1-2/B	47961	HR/OL/10M/1-2/N	47971	2000 PSI (138 BAR)	1/2"	1/2"(12.7mm)	7/8"(21.5mm)	10 m (32.8')
GREASE - HIGH PRESSURE HOSE REELS								
HR/GR/10M/1-4/B	47980	HR/GR/10M/1-4/N	47990	5800 PSI (400 BAR)	1/4"	1/4"(6.35mm)	5/8"(15.9mm)	10 m (32.8')
HR/GR/10M/3-8/B	47981	HR/GR/10M/3-8/N	47991	4000 PSI (276 BAR)	3/8"	3/8"(9.5mm)	3/4"(19mm)	10 m (32.8')

121



125



126



WASTE OIL

handling

Tough job-site tested products for convenient & safe handling of waste oil

NEW PRODUCTS

to look out for

121 AIR OPERATED DOUBLE DIAPHRAGM
WASTE OIL PUMPS

125 LOW PROFILE TRUCK DRAIN

126 DRAIN PANS

110

AIR OPERATED DOUBLE DIAPHRAGM WASTE OIL PUMPS

NEW!

AODD

Air Operated Double Diaphragm Pumps with Heavy Duty Aluminium Body Construction, Hytrel® seals & ball valve are ideal for transferring Used Oil

Designed to Handle a wide variety of fluids with high solids content: No close fitting or rotating parts so liquid with high solids content and/or size can be easily pumped.

Pumps can transfer contaminated media & are good at cleaning out pits or liquids that can be a mix of several products like oil, water and antifreeze all mixed together.

The gentle nature and minimal parts contact with the liquid makes these pumps an excellent choice for shear sensitive fluids

All pump Models are designed for use with an Inlet Air Pressure of 20 – 100 PSI (1.40 to 6.89 BAR). Air Inlet on all pump models is threaded ¼" NPT (F)



AODD/1-2/BAH/N



AODD/3-4/BAH/N



AODD/0-1/BAH/N

	AODD/1-2/BAH/N	AODD/3-4/BAH/N	AODD/0-1/BAH/N
Size	1/2"	3/4"	1"
Casing	Aluminium	Aluminium	Aluminium
Diaphragm	Hytrel®	Hytrel®	Hytrel®
Flow rate	0 - 50 LPM (0 - 13.22 GPM)	0 - 110 LPM (0 - 29.1 GPM)	0 - 110 LPM (0 - 29.1 GPM)
Pump Inlet/ Outlet NPT (F)	1/2"	3/4"	1"
Air Exhaust NPT(F)	3/8"	3/4"	3/4"
Max Particle Size	1/32" (1 mm)	1/16" (2.0 mm)	1/16" (2.0 mm)
Suction Lift (DRY)	5-feet	18-feet	18-feet
Max Air Consumption	450 LPM (15.9 CFM)	1200 LPM (42.4 CFM)	1200 LPM (42.4 CFM)
Wetted Components	Aluminium, PA, Stainless steel, Hytrel®	Aluminium, Stainless steel Hytrel®	Aluminium, Stainless steel, Hytrel®
Valve Ball Material	Hytrel®	Hytrel®	Hytrel®
Air Motor	Aluminium	Aluminium	Aluminium
Maximum Liquid Temperature	80°C (176°F)	80°C (176°F)	80°C (176°F)

CAT NR.	ORD NR.	SIZE	CASING	DIAPHRAGM	RECOMMENDED FLUIDS
AODD/1-2/BAH/N	44720	1/2"	Aluminium	Hytrel®	Diesel fuel, Kerosene, Lubricants, Gear oil, Engine oil, Waste oil, Brake fluid, Naphtha, Mold lubricants, Antifreeze and Waste water
* AODD/3-4/BAH/N	44730	3/4"	Aluminium	Hytrel®	Diesel fuel, Kerosene, Lubricants, Gear oil, Engine oil, Waste oil, Brake fluid, Naphtha, Mold lubricants, Antifreeze and Waste water
* AODD/0-1/BAH/N	44740	1"	Aluminium	Hytrel®	Diesel fuel, Kerosene, Lubricants, Gear oil, Engine oil, Waste oil, Brake fluid, Naphtha, Mold lubricants, Antifreeze and Waste water

Key * Best Seller

Oil Drain with wheel mounted tank for gravity draining of motor, engine, gearbox & differential oils, transmission & power steering fluids etc. from all types of motor vehicles placed on auto lift or a pit

Centrally Mounted 10 Litres (10.50 qt.) capacity bowl is height adjustable & can be optimally positioned allowing oil draining as well as other maintenance operations

Durable all-steel design and reinforced castors; the unit provides a safe & affordable option for draining, transferring & evacuating used oil

Designed for excellent mobility, easy bowl positioning & simple to use pressurized evacuation

Comes complete with a 14" (355mm) telescopic bowl that can be adjusted from 45" (1143 mm) to 72" (1828 mm)

68 Litre (18 gallon) tank includes a preset air regulator that allows the use of standard compressed air upto 150 PSI (10 BAR)

Tank includes a safety valve and a reinforced dispensing hose that doubles as a sight gauge to prevent overfilling

Not for use with fuels and corrosive media



Bowl fitted with Anti-Splash Screen



Dispensing Hose doubles as a sight gauge to prevent over filling



Lockable Front Wheels provide stability to the unit

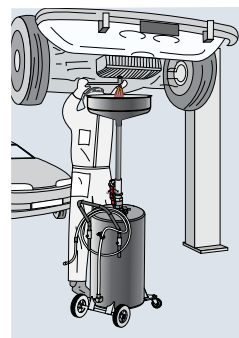

Used Oil being drained from vehicle in an automotive workshop



Tank Capacity	68 Litre / 18 Gallons
Max. Collection capacity	55 Litre / 14.5 Gallons
Bowl Capacity	10 Litres / 10.50 Quarts
Bowl inner Diameter	14" (355 mm)
Length of draining Hose	2 meter
Maximum Height	72" (1828 mm)
Minimum Height	45" (1143 mm)
Recommended Draining Pressure	8 PSI (0.5 BAR)

CAT. NR.	ORD. NR.
WOD/68A	44601

112

WASTE OIL DRAIN - GRAVITY FEED

WOD -30

WOD -50

Oil Drain with wheel mounted tank for gravity draining of motor, engine, gearbox & differential oils, transmission & power steering fluids etc. from all types of motor vehicles placed on auto lift or a pit

Centrally Mounted 10 Litres (10.50 qt.) capacity bowl is height adjustable & can be optimally positioned allowing oil draining as well as other maintenance operations

Bowl comes fitted with Anti Splash Screen

Durable all-steel design and re-enforced castors; the unit provides a safe & affordable option for draining, transferring & evacuating used oil

Designed for excellent mobility, easy bowl positioning & simple to use gravity evacuation

Comes complete with a 14" (355 mm) telescopic bowl with height adjustment option

Tank comes fitted with Sight Gauge to check waste oil level & a Ball Valve to drain out oil

Not for use with fuels and corrosive media



Bowl fitted with Anti-Splash Screen



Telescopic,
10 litre
capacity bowl

Sight
Gauge

Ball Valve

WASTE OIL HANDLING

	WOD-30G	WOD-50G
Tank Capacity	30 Litre / 8 Gallons	50 Litre / 13 Gallons
Bowl Capacity	10 Litres / 10.50 Quarts	10 Litres / 10.50 Quarts
Bowl inner Diameter	14" (355 mm)	14" (355 mm)
Maximum Height	55" (1400 mm)	63-1/2" (1613 mm)
Minimum Height	40" (1016 mm)	40" (1016 mm)

CAT. NR.	ORD. NR.	TANK CAPACITY
WOD/30G	44610	30 litres / 8 gallons
WOD/50G	44611	50 litres / 13 gallons

Heavy duty Oil Pumps designed specifically to transfer bulk oils, hydraulic oils, used oil, antifreeze or antifreeze mixes

Non-corroding Aluminium die cast pump body

A high horsepower to flow ratio assures adequate power to pump viscous fluids at low temperatures

Sintered powder metal gears

Self-priming, positive displacement design

Pump has an internal bypass valve to bypass flow if the discharge pressure exceeds bypass valve setting

Built-in 2" bung adaptor for mounting directly onto drums and tanks

Includes filter screen that fits at the bottom of the suction tube for use with waste oil

Available in two versions:

- a. AC Regular Flow
- b. AC High Flow

WETTED COMPONENTS

Aluminium, Steel, Cast Iron, Nylon, NBR, Zinc, Polypropylene, PVC

RECOMMENDED USE

Oils, Synthetic Oils, Antifreeze, Used Oils, Hydraulic Fluids, Cutting Oils, Oil based herbicides, Non-flammable oil based solvents, Liquid soap etc.

CAT NR.	ORD. NR.
OPM/115	45550
OPM/220	45551
OPM/115/HF	45555
OPM/220/HF	45556
KIT/OPM	45565

OPM/115

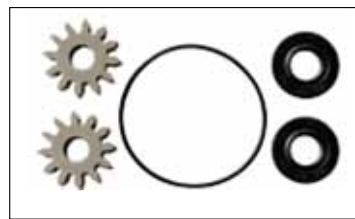
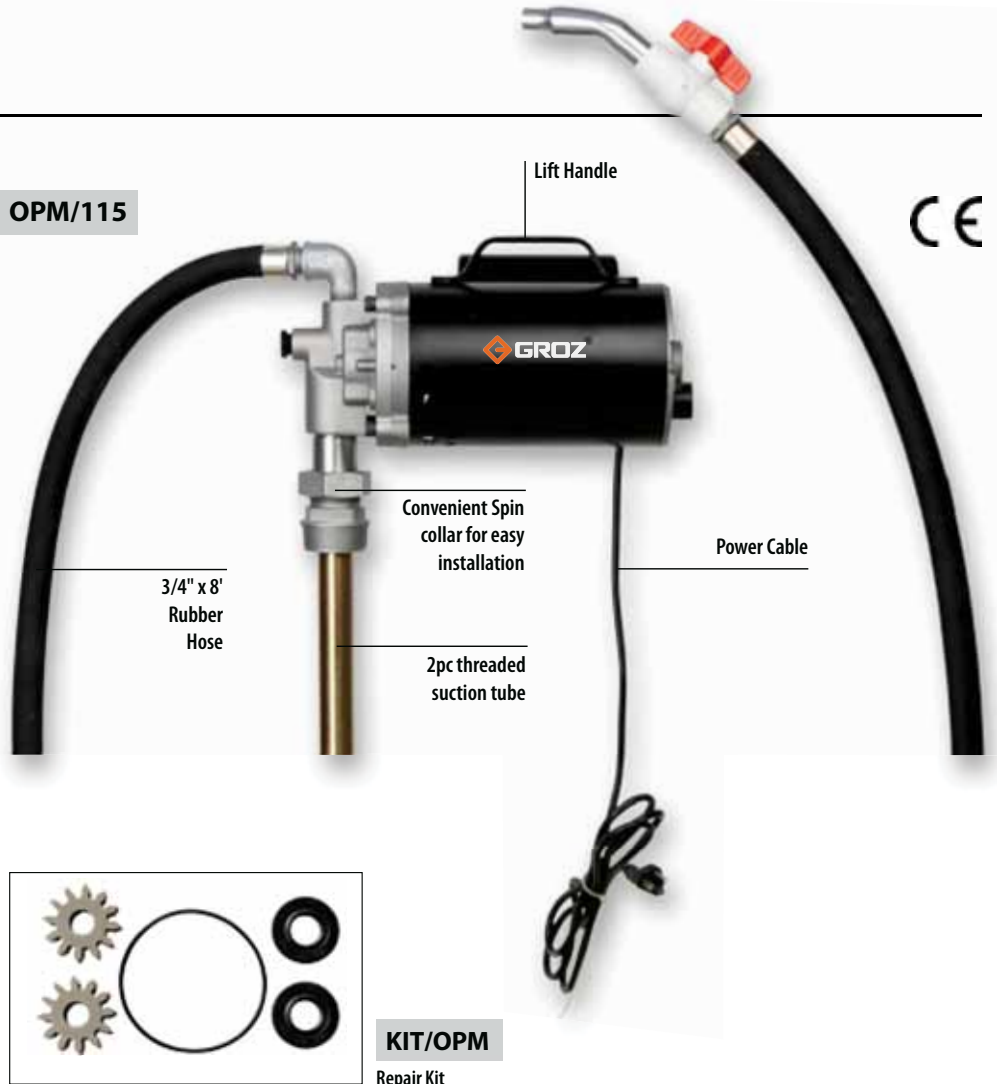

KIT/OPM

Repair Kit

	AC REGULAR FLOW		AC HIGH FLOW	
	OPM/115	OPM/220	OPM/115/HF	OPM/220/HF
Description	Heavy Duty 115V AC	Heavy Duty 220V AC	High Flow Heavy Duty 115V AC	High Flow Heavy Duty 220V AC
Flow	Up to 4.4 GPM (16.6 LPM)	3.70 to 4.4 GPM (14 to 16.6 LPM)	Up to 8 GPM (30 LPM)	Up to 6.5 GPM (25 LPM)
Motor	½ HP 115V AC, 60 Hz	½ HP 220V AC, 50/60 Hz	½ HP 115V AC, 60 Hz	½ HP 220V AC, 50/60 Hz
Amp	9 Amp	6 Amp	9 Amp	6 Amp
RPM	1720	1440/1720	3400	2800 / 3360
Mechanism	Gear Pump	Gear Pump	Gear Pump	Gear Pump
Suction pipe	34" long	34" long	34" long	34" long
Hose	¾" X 8'	¾" X 8'	¾" X 8'	¾" X 8'
Bung Adaptor	2" Threaded	2" Threaded	2" Threaded	2" Threaded
Inlet	1" NPT	1" NPT	1" NPT	1" NPT
Outlet	¾" NPT	¾" NPT	¾" NPT	¾" NPT
Dispensing Nozzle	Ball Valve	Ball Valve	Ball Valve	Ball Valve
Power Cable Length	8'	8'	8'	8'
Air Cooled	Yes	Yes	Yes	Yes
Max. Viscosity of Oil	SAE 90	SAE 90	SAE 90	SAE 90
Max. Working Pressure	65 PSI (4.5 BAR)	65 PSI (4.5 BAR)	65 PSI (4.5 BAR)	65 PSI (4.5 BAR)
Thermal Protection	Yes	Yes	Yes	Yes

114

LOW PROFILE TRUCK DRAIN

NEW!

TD/68

Designed for use with Heavy-Duty Trucks, Buses, RV's & other low profile automobiles

Rugged steel construction makes it ideal for use in heavy duty repair shops

With a 7-1/2" (190 mm) ground clearance, this drain fits under most automobiles

Drain capacity 18 gallons (68 Litres)

Available in a choice of Gravity version or fitted with Manual Rotary pump for pumping out used oil



WASTE OIL HANDLING

CAT. NR.	ORD. NR.	DESCRIPTION	LENGTH (l)	WIDTH (w)	HEIGHT (h)
TD/68G	45802	Gravity Oil Drain	41.92" (1065 mm)	36" (560 mm)	7-1/2" (190 mm)
TD/68P	45803	Oil Drain with Manual Rotary Pump	41.92" (1065 mm)	36" (560 mm)	7-1/2" (190 mm)

115

DRAIN PANS

NEW!

ODP-16

High Density Polyethylene Construction

Chemical / Solvent Resistant

Designed to ship in nested form

Approximate Size

23.22" X 18.43" X 5.78"
(590mm x 468mm x 147mm)

Large Spout for fast pouring

Built-In Anti-Splash Lip & Baffles

Includes large handle

Anti spill spout cap



ODP-16/GN

ODP/16



Designed to ship in nested form

CAT. NR.	ORD. NR.	CAPACITY	RECOMMENDED USE	COLOUR
* ODP/16	41960	16 Litres (4-1/4 Gallons)	Waste Oil	Black
ODP/16/GN	41961	16 Litres (4-1/4 Gallons)	Anti-Freeze	Green

Key * Best Seller

SPECIALITY

pumps

Smart Pumps for
total fluid handling needs

NEW PRODUCTS to look out for

131 AIR OPERATED DEF TRANSFER PUMP

136 BATTERY OPERATED PLASTIC PUMP

138 SAFETY PUMPS

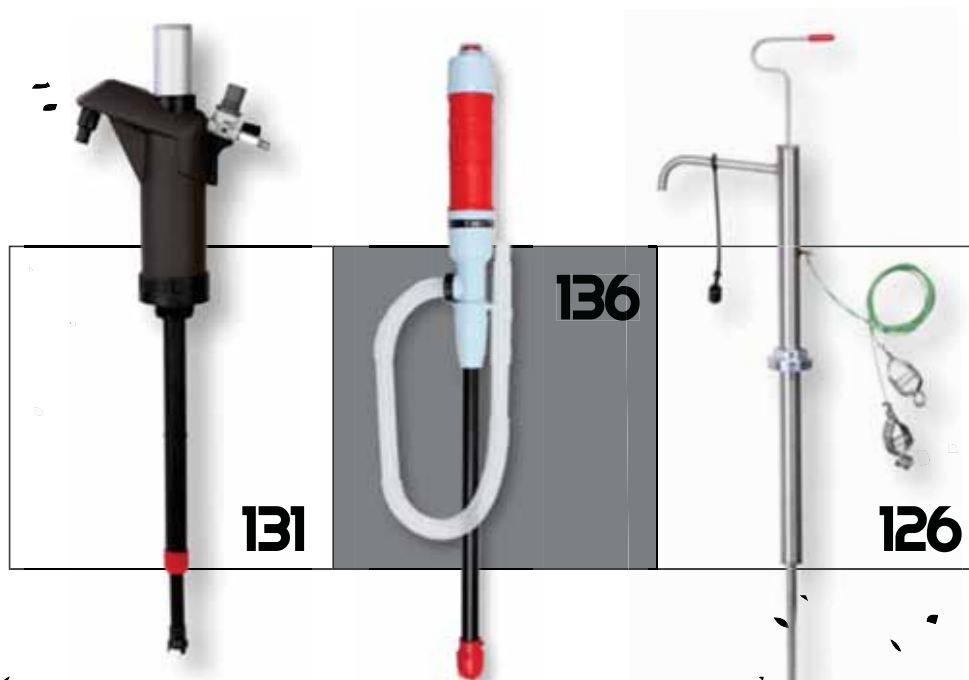

DIAPHRAGM / BILGE PUMP

DPP-20



INDUSTRIAL



AUTOMOTIVE



AGRICULTURE

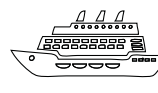

MARINE

Hand Operated Diaphragm pump, designed to work in any position-vertical, horizontal, at an angle or even upside down

Pump can be mounted anywhere: on a wall, wooden base, on a drum etc.

Pump handle can be fitted in line or at 90 degrees to the inlet & outlet ports, which makes installation very easy

Constructed from minimal parts, the pump is virtually maintenance free. The choice of materials used in the pump construction allows high chemical compatibility making it useful for a variety of applications in Industrial, Agricultural, Automotive & Marine

Designed to operate as a Bilge pump to evacuate standing bilge water

WETTED COMPONENTS

Polyacetal, Thermoplastic Polyurethane, Stainless Steel & PVC

RECOMMENDED USE

Water, Sea Water, Diesel, Bio Diesel, Kerosene, Gasoline, Mineral Oils, Heating Oils, Synthetic Oils, Engine Oils, Antifreeze, emulsions & liquids with small bodies in suspension

DO NOT USE WITH

Urea, food grade media or any media not compatible with the pump components

DPP/20

Pump supplied complete with Suction & Discharge Hose (1" I.D. x 2 m), Delivery Nozzle & Hose Clamps, Drum Attachment Kit for converting pump for mounting on drums with a 2" opening; complete with Suction Drum Hose (3/4" I.D. x 1.25 m), Connecting Links & Strainer



DPP/20A

Pump supplied complete with Suction & Discharge Hose (1" I.D. x 2 m long), Delivery Nozzle & Hose Clamps



DPP/20B

Pump only with 1" (25 mm) Inlet & Outlet Hose Barb ports

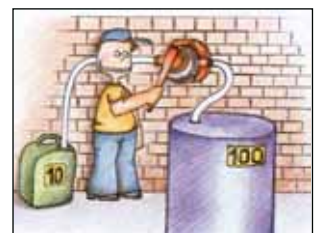

CAT. NR.	ORD. NR.
DPP/20	44500
DPP/20A	44501
DPP/20B	44502

DELIVERS

Upto 16.6 litres / minute
Upto 4.40 gal. / minute



TEMPERATURE

-10°C to +40°C
(14°F to 104°F)



117

DIAPHRAGM PUMP FOOD GRADE

DPP-30



FOOD



AGRICULTURE

Hand Operated Diaphragm pump, designed to work in any position-vertical, horizontal, at an angle or even upside down

Pump can be mounted anywhere: on a wall, wooden base, roof etc.

Pump handle can be fitted in line or at 90 degrees to the inlet & outlet ports, which makes installation very easy

Constructed from minimal parts, the pump is virtually maintenance free.

The choice of materials used for pump construction allow it's use with liquid foodstuffs making it useful for a variety of applications in agricultural, preservation applications, wine making, oil production etc.

Comes complete with pump body, suction & discharge hose (1" I.D. x 2m), delivery nozzle & stainless steel hose clamps (3)

WETTED COMPONENTS

Food grade Polyacetal, Food Grade Thermoplastic Polyurethane & Food Grade PVC

RECOMMENDED USE

Aqueous foods, acidic foods with pH < 5, such as water, cider, fruit or vegetable juices, lemonade, soda, syrups, coffee, tea, liquid chocolate, beer, wine, brandy, liqueurs, vegetable oils, milk, vinegar etc.

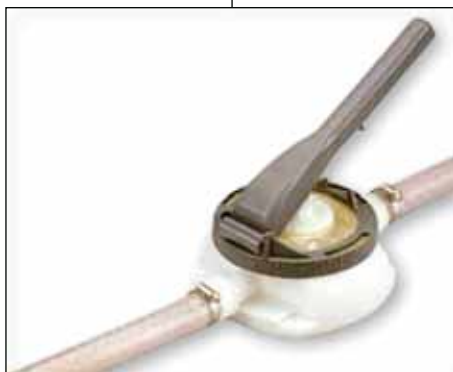

Suction Hose (1" ID x 2m)
Discharge Hose (1" ID x 2m)

SPECIALITY PUMPS

DELIVERS 

Upto 16.6 litres / minute
Upto 4.40 gal. / minute

TEMPERATURE 

-10°C to +40°C
(14°F to 104°F)

CAT. NR.	ORD. NR.
DPP/30	44510



WORKSHOP



AGRICULTURE



AUTOMOTIVE



INDUSTRIAL

Lever Action Barrel pump, designed for use with high viscosity oils, agricultural chemicals etc.

Pump design makes it extremely convenient & comfortable to pump thick oils without excessive fatigue

Choice of materials used in the pump construction, makes it versatile for use with water based media, and select chemicals

Built-In 2" Bung Adaptor allows the pump to be fixed on drums with 2" opening

Pump position can be adjusted using the Lock Nut incorporated in the pump body

Pump outlet is fitted with an Air Vent Cap which when loosened breaks the siphon action

Supplied complete with suction tube for use with 50-205 Litre (15- 55 gl) drums & 2m x 3/4" flexible corrugated discharge hose

WETTED COMPONENTS

Polyacetal, Polypropylene, Polyethylene, PVC & Viton

FOR USE WITH

Water-based media, detergents, soaps, antifreeze, windshield washer, Lubricants, Herbicides & Pesticides, Adblue, Urea, DEF etc.. Pump should only be used with Non-flammable liquids

BUNG/P/TS



Also available with tri-sure adaptor making the pump suitable for use on plastic drums with buttress threads

! WARNING

These pumps must never be used for Fuel Transfer or with Thinners, Solvents, Hydraulic Oils etc.

Do not use with any media not compatible with materials used in the pump construction.

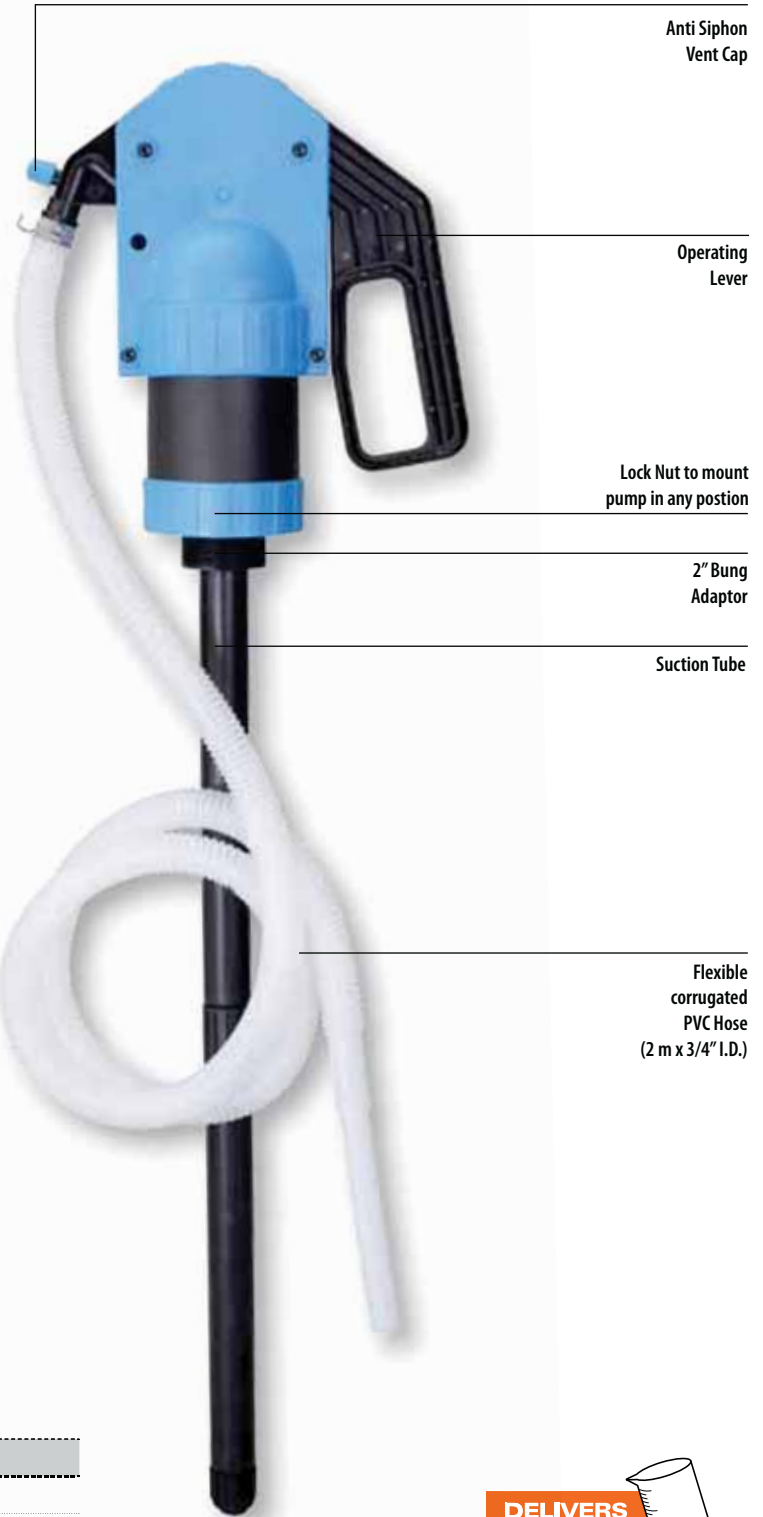

Anti Siphon Vent Cap

Operating Lever

Lock Nut to mount pump in any position

2" Bung Adaptor

Suction Tube

Flexible corrugated PVC Hose (2 m x 3/4" I.D.)

CAT. NR.	ORD. NR.	DESCRIPTION
PLP/02	44185	Pump with 2" Bung Adapter
PLP/02T	44167	Pump with 2" Bung Adapter & an additional Tri Sure adapter
BUNG/P/TS	44166	Spare Tri Sure Adapter

DELIVERS



Upto 500 ml / 1 pint per stroke

119

AIR OPERATED DEF TRANSFER PUMP



PAOP-1



AGRICULTURE



INDUSTRIAL



AUTOMOTIVE



WORKSHOP

Air Operated Transfer Pump for dispensing DEF

Choice of materials makes it compatible with many more fluids, compared to other air pumps which primarily pump Oil

Built-In 2" bung adaptor allows the pump to be fixed on drums with 2" opening. Pump position can be adjusted using the lock nut incorporated in the pump body

Air Supply is provided via a Ball Valve connected to an Air Regulator which limits max. air pressure to 100 PSI (7 BAR)

Supplied complete with suction tube with check valve for use with 50 – 205 litre (15-55 gl) drums

Available as pump only or pump complete with 2m hose, safety bracket and manual dispensing nozzle

WETTED COMPONENTS

Polypropylene, Viton, Stainless Steel, Nylon*, PVC*
*only pump with hose & nozzle

RECOMMENDED USE

Water-based media, Detergents, Soaps, Antifreeze, Windshield Washer, Hydraulic Oils, Lubricants, Herbicides & Pesticides, Adblue, Urea, DEF etc. Pump should only be used with Non-flammable liquids

DO NOT USE WITH

Any media not compatible with materials used in the pump construction.



WARNING

Pump must never be used for Fuel Transfer or with Thinners, Solvents etc.

Air Motor

Air Regulator

Ball Valve

Pump Outlet

Air Inlet

Large 9" (228 mm) Clearance to re-fill small containers

PAOP/1

Lock Nut to Mount Pump in Any Position

2" Bung Adaptor

DELIVERS



Upto 30 LPM (8 GPM)

Working Pressure	2 – 10 BAR (30 – 100 PSI)
Max. Air Inlet Pressure	7 BAR (100 PSI)
Max. Outlet Pressure	3 BAR (45 PSI)
Air Consumption	125 LPM (4.40 CFM)
Max. Pump Discharge	30 LPM (8 GPM) at Air Pressure of 7 BAR (100 PSI)
Air Inlet Connection	¼" (F)
Pump Outlet	¾" (19.5 mm) dia.
Pump Inlet	1" (F)
Noise Level	78 db
Max. Temperature of media being pumped	60°C (140°F)
Max. Viscosity of media being pumped	SAE 50 / ISO 220

Telescopic Suction Tube, extends from 20-1/2" (520mm) to 36" (915 mm)

PAOP/1H



Check Valve

CAT. NR.	ORD. NR.	DESCRIPTION
PAOP/1	45315	Pump Only
PAOP/1H	45316	Pump with 2m PVC Hose (3/4" I.D.), Nylon Body Dispensing nozzle, 2 Hose Clamp and Safety Steel Bracket

120

PLASTIC ROTARY PUMPS



AUTOMOTIVE



INDUSTRIAL



AGRICULTURE

A range of special application pumps designed for use with media that cannot be pumped using a regular cast-iron or steel pump

Choice of 4 configurations built using different materials for handling mild to very aggressive media

Pump body & handle are constructed using glass filled Polypropylene'

Vanes made out of Ryton

Complete with 3 pc threaded suction tube for use on 50 Litre (15 gallon) to 205 Litre (55 gallon) drums

DELIVERS



Upto 5 litres (1.3 gallon) per 20 turns

Below tabulation details construction & application details of the 4 pump types:

	ERP/01	PRP/02	PRP/01	PRP/10
Description	Standard	DEF	Professional	Heavy Duty
Body Colour	Black	White	Yellow	Blue
Rotor Material	Polypropylene	Polypropylene	Ryton	Ryton
Handle Material	PPCP	40% Glass Filled PP	40% Glass Filled PP	Aluminum Die Cast
Shaft Seal	Viton	Viton	Viton	PTFE
Fasteners	Steel	Stainless Steel	Stainless Steel	Stainless Steel
Inlet Threads	Custom	Custom	Custom	3/4" BSP (F)
Outlet Threads	Custom	Custom	Custom	3/4" BSP (F)
Discharge Tube Material	PPCP	PPCP	PPCP	Stainless Steel SS 304
Suction Tube	PPCP	PPCP	PPCP	Stainless Steel SS 304
Strainer at Suction Tube Inlet	Yes	Yes	Yes	No
Non Return Valve at Suction Tube Inlet	Yes	Yes	Yes	No
Bung Adaptor Material	PPCP	PPCP	PPCP	Cast Iron
Bung Adaptor Spec.	2" for Metal Drums	2" for Metal Drums & 2nd adaptor for Plastic Drums	2" for Metal Drums & 2nd adaptor for Plastic Drums	2" for Metal Drums
Wetted Components	Polypropylene, Ryton, Viton	Polypropylene, Ryton, Viton	Polypropylene, Ryton, Viton	Polypropylene, Ryton PTFE, Stainless Steel
Typical Use	Infrequent / Light Use	Medium Use	Heavy Use	Tough Use

ERP-01

PRP-01

NEW!

PRP-02

NEW!

PRP-10



RECOMMENDED USE
Light Oils, Antifreeze

DO NOT USE
Acids, Chemicals, Solvents etc.

CAT. NR.	ORD. NR.
ERP/01	44196



RECOMMENDED USE
DEF, Adblue, Urea

DO NOT USE
Acetone, Lacquer, Mineral Oils, Solvents, Turpentine Oil etc.

CAT. NR.	ORD. NR.
PRP/02	44145



RECOMMENDED USE
Acids, Chemicals, Water based media, antifreeze, detergents, Urea, Adblue, DEF, Benzene, Glycerine etc.

DO NOT USE
Acetone, Lacquer, Mineral Oils, Solvents, Turpentine Oil etc.

CAT. NR.	ORD. NR.
PRP/01	44191



RECOMMENDED USE
Esters- Ethyl Acetate
Alcohols- Ethyl Alcohol, Benzyl Alcohol, Butyl Alcohol, Methyl Alcohol
Ketones- Acetone, MEK
Bases- Ammonium Hydroxide, Potassium Hydroxide, Sodium Hydroxide, Baking Soda, detergents etc.
Hydrocarbons- Ethylene Glycol, Naptha, Fuel Oils, Phenol, Water Based Media, Antifreeze, Urea, Adblue, DEF

DO NOT USE
With Benzoic Acid, Gasoline, Lacquers, Thinners, Bleach, Benzene, Toluene, Xylene, Turpentine Oil, Jet Fuel etc.

¾" Inlet & Outlet threads on the pump also make it suitable for use on IBC's/ Totes, connecting with standard fittings

CAT. NR.	ORD. NR.
PRP/10	44144

SPECIALITY PUMPS

121

POLYPROPYLENE CHEMICAL PUMP

CMP-10



INDUSTRIAL



WORKSHOP



AUTOMOTIVE



Self priming Vertical Lift Pump designed for use with antifreeze, detergents etc.

Polypropylene construction with steel plunger rod & viton seals

Complete with 2" polypropylene bung adaptor for use on 205 litre (55 gallon) drums

WETTED COMPONENTS

Polypropylene, Steel & Viton

RECOMMENDED US

Antifreeze, detergents, windshield fluids, glycerine, mild acids, most petroleum based media etc.

DO NOT USE

With strong acids, lacquers, acetone, gasoline etc.

CAT. NR.	ORD. NR.
CMP/10	44192

DELIVERS



Upto 400 ml (14 oz.) / stroke

122

NYLON CHEMICAL PUMP

CMP-12



AUTOMOTIVE



INDUSTRIAL



AGRICULTURE

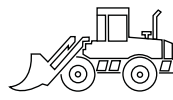

CONSTRUCTION



WORKSHOP



Self priming Vertical Lift Pump designed primarily for use with lacquer thinners, Urea, AdBlue, DEF etc.

Nylon construction with stainless steel plunger rod & PTFE seals

Complete with 2" polypropylene bung adaptor

Available in a choice of full length pump for use on 55 gallon (205 litre) drums or stub pump for use on 25 litre drums

WETTED COMPONENTS

Nylon, Polypropylene, Stainless Steel & PTFE

RECOMMENDED USE

Lacquer Thinners, Acetone, Antifreeze, Brake Kleen, Detergents, Glycerine, Water, Weed Killer, mild acids, AdBlue, Urea, DEF, Petroleum based media etc.

DO NOT USE

With strong acids, bleach, gasoline etc.

CAT. NR.	ORD. NR.	FOR USE ON	MAX. DELIVERY
CMP/12	44193	205 litre (55 gal) drums	400 ml (14 oz.) / stroke
◆ CMP/12S	44186	25 litre drums	120 ml (4.20 oz.) / stroke

Key ◆ New

DELIVERS



Upto 400 ml (14 oz.) / stroke

123

SIPHON PUMPS



WORKSHOP



AUTOMOTIVE

- SPH-1
- SPH-2
- SPH-3

Easy to use, polyethylene pumps siphon liquids to lower levels than the height at which the pump is installed.

These are easy to prime & start within 6-7 strokes. Pump requires no further operation & keeps working in Auto position.

All pumps are equipped with a Vent Cap on top. Opening the cap stops discharge

To dispense media at levels higher than the pump, pump below needs to be continuously operated

Supplied complete with flexible corrugated discharge tube

RECOMMENDED USE

Water-based fluids, detergents, waxes, soaps, antifreeze, some mild acids, and other liquids compatible with pump construction materials

Pump should only be used with light weight & non-flammable liquids

DO NOT USE

With any media not compatible with materials used in the pump construction

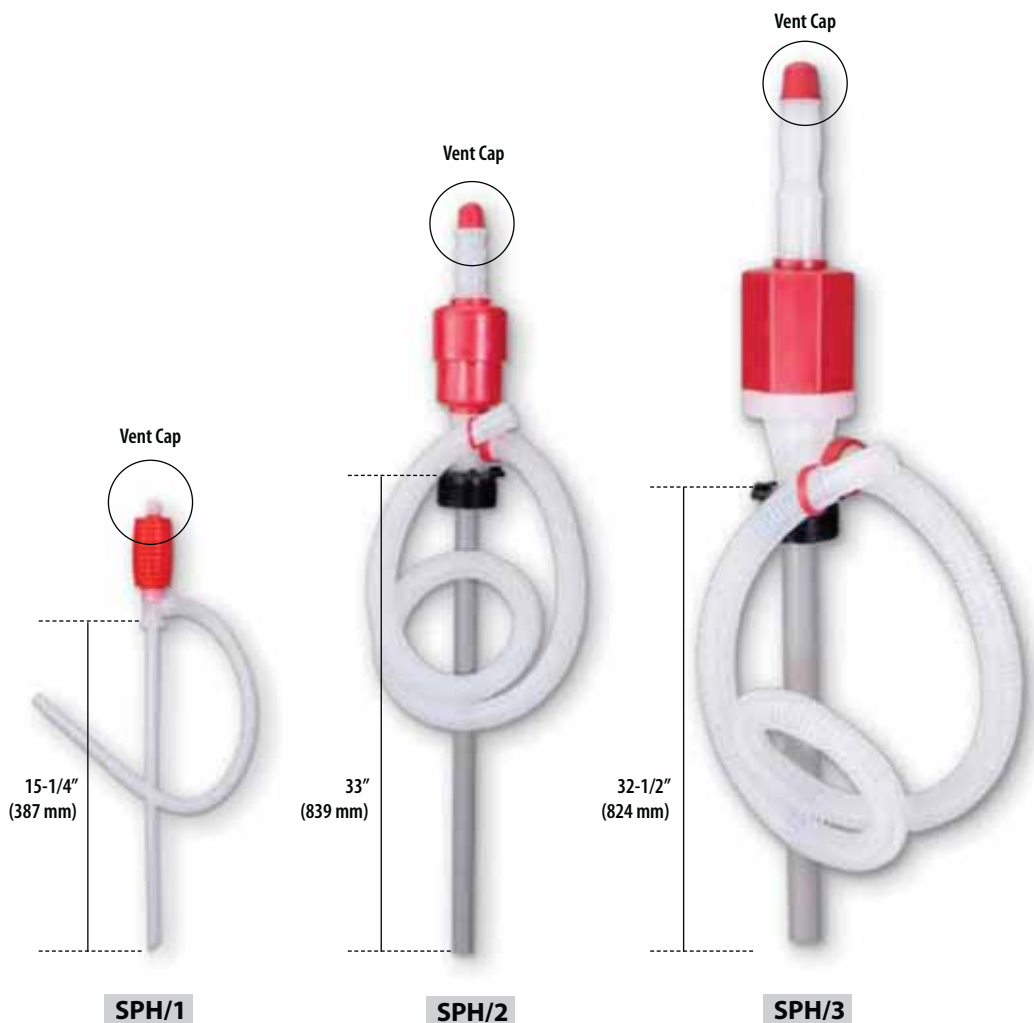

SPECIALITY PUMPS

! WARNING

Pumps must never be used with Hot Media at temperatures above 60° C (140° F)

These pumps must never be used with concentrated acids, Acetone, Benzene etc

CAT. NR.	ORD. NR.	DISCHARGE	BUNG	FITS	DISCHARGE HOSE LENGTH	WETTED COMPONENTS
SPH/1	44400	6.5 LPM / 2 GPM	1-1/2" for use with pails	5 - 20 litre / 5 gal. pails	21.69" (551 mm)	Polyethylene
SPH/2	44401	17.5 LPM / 5 GPM	2" for use with drums	205 litre / 55 gal. drums	46.45" (1180 mm)	Polyethylene & Polypropylene
SPH/3	44402	21 LPM / 7 GPM	2" for use with drums	205 litre / 55 gal. drums	47.70" (1212 mm)	Polyethylene & PVC

124

BATTERY OPERATED PLASTIC PUMP



WORKSHOP



AUTOMOTIVE

NEW!

BOP-5

Battery Operated pump for quick & convenient transfer of Diesel, Kerosene, Light oils & water based media

Ideal for transferring small qty's of media into boats, garages & small shops

Self Priming pump. Works on a battery operated 3V DC motor

Pump is operated by pressing the actuation button located on top

Suitable for use on 20 litres/ 5 gallon drums

Works on 2 "D" size (LR20) Alkaline Batteries (not included with the pump). Approx. working life with one set of batteries is 396 gallons (1500 Litres)

Complete with 23-1/2" (600 mm) long flexible corrugated discharge hose

Hang Hole provided at top allows pump to be conveniently stored when not in use

WETTED COMPONENTS

Polypropylene, Polyethylene, NBR, SS, PVC & Acetal

RECOMMENDED USE

Diesel, Kerosene, Light Oils, Water & other Water based media compatible with pump components. Pump should be used with light weight & non flammable liquids only

DO NOT USE

With any media not compatible with materials used in the pump construction. Pump must never be used with acids, Acetone, Benzene etc.



WARNING

Pump must never be used with Hot Media at Temperatures above 60°C (140°F)

DELIVERS

Upto 7 LPM (1.8 GPM)

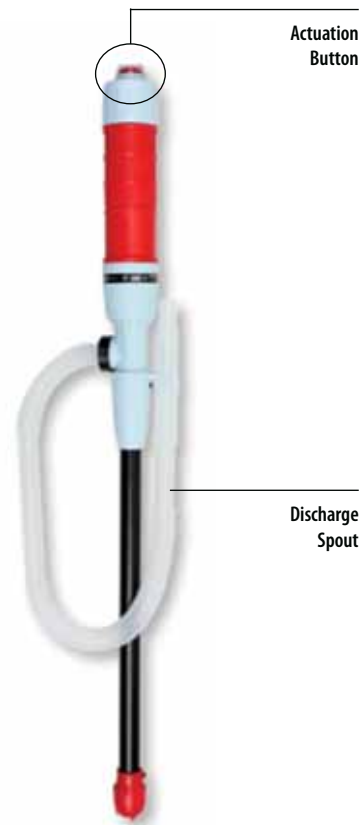

CAT. NR.	ORD. NR.	TOTAL LENGTH	SUCTION TUBE LENGTH
BOP/5	44410	24.6" (625 mm)	14.8" (375 mm)

125

TIRE SEALANT PUMP



CONSTRUCTION



AGRICULTURE

TSP-03

Hand operated Tire Sealant Pump for pumping Tire Sealant from 5 to 6.1/2 gallon pails directly into tubeless tyres

Powder coated pump body with aluminum die cast adjusting flange & pump handle

Includes adjusting collar to pre-set amount dispensed per stroke

Powder coated 12" (310 mm) steel drum cover

Complete with 5' braided PVC hose fitted with quick connect valve stem coupler, non-return valve included

WETTED COMPONENT

Steel, Aluminum, NBR, PVC

DELIVERS

Upto 230 ml (8 oz.) / stroke



Pump Outlet

Adjusting Collar

Adjusting Flange



CAT. NR.	ORD. NR.
TSP/03	44199

126

BRASS TRANSFER PUMPS



AUTOMOTIVE



AGRICULTURE

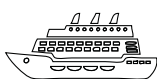

MARINE

BLG-1

BLG-2

A choice of 2 Portable Hand pumps that provide clean, quick, hassle free transferring or evacuating of a wide variety of media including engine oil, coolants, transmission fluid, power steering fluid, oils, diesel, water, Antifreeze etc.

Pumps have a non corroding premium Brass construction & hand removable Neoprene caps. These are small & lightweight & fit easily in a toolbox or the trunk of a car

Self priming

Smooth & easy Operation
Fully serviceable with no threaded parts

For use on cars, boats, motorcycles, ATV's, lawn & garden equipment etc.

TEMPERATURE



Max. Temperature: 60°C (140°F)

Typical applications for BLG/1 include



- Draining out oil from crank case or ATF through dipstick hole. Does it from under the hood & not under the car
- Cleaning sludge accumulation from oil filter case
- Removing water from radiator to add antifreeze or to service thermostat or pump
- Draining Stopped sinks
- Transferring fluids from one container to another, without lifting
- Pumping water out of small boats



BLG/2

DELIVERS



Upto 250 ml (8.50 oz.) per stroke

Comes complete with 60" (1500 mm) of 1/2" (12 mm) dia. discharge hose.

Ideal for use as a Transfer/Bilge pump with Oils, diesel, water, Antifreeze etc..

1-1/4" (32 mm)

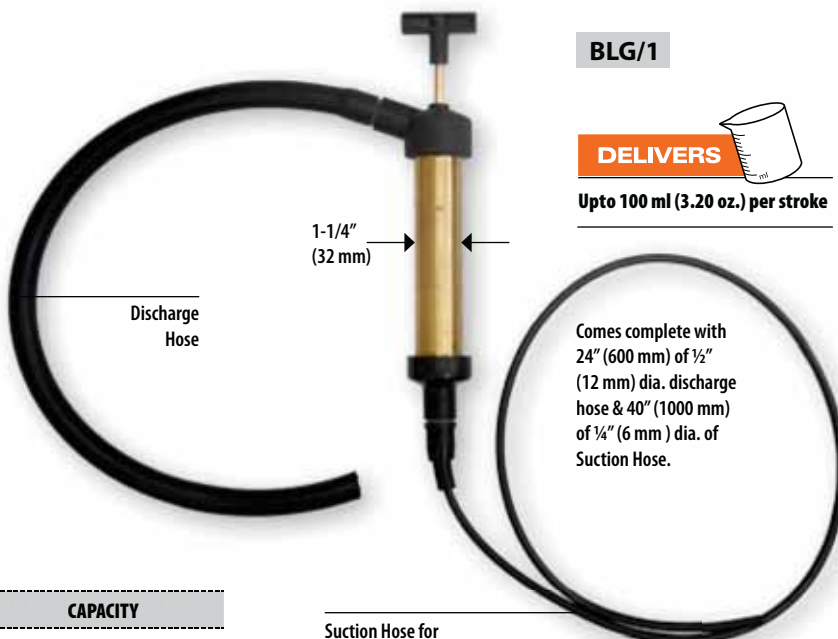

BLG/1

DELIVERS



Upto 100 ml (3.20 oz.) per stroke

Comes complete with 24" (600 mm) of 1/2" (12 mm) dia. discharge hose & 40" (1000 mm) of 1/4" (6 mm) dia. of Suction Hose.

Discharge Hose

1-1/4" (32 mm)

Suction Hose for Dipstick hole

CAT. NR.	ORD. NR.	OVERALL LENGTH	CAPACITY
BLG/1	44520	10.1/2" (265 mm)	100 ml (3.20 oz.) per stroke
BLG/2	44521	17" (430 mm)	250 ml (8.50 oz.) per stroke

SAFETY PUMPS



INDUSTRIAL



AUTOMOTIVE



WORKSHOP



AGRICULTURE

316 Stainless Steel Hand Operated Pumps for use with combustible & flammable media.

Built-in Internal Flame Arrestor prevents flame flashback

Heavy-Duty bonding & grounding wires prevent hazardous static charge. Wires are secured by locknut & have heavy-duty Alligator Clips

Pump body made from 316 Stainless Steel with PTFE Piston & PTFE Sealing Gasket

Available in a choice of Vertical Lift & Lever Action for use with 5 gallon (20-30 litre) pails or 15-55 gallon (50 to 205 litre) drums. Pail pump comes with 4 screw cap adapters (1-3/4", 2-1/8", 2-1/4" & 2-7/8") for use with most common pails. Drum pump comes with 2" Bung Adapter

WETTED COMPONENTS

316 Stainless Steel, PTFE

RECOMMENDED USE

Gasoline, Diesel, Kerosene, Lacquer, Thinners, Acetone, Benzene, Naphtha, Urea, DEF, Adblue etc. (detailed list on adjoining page)

DO NOT USE WITH

Hydrochloric Acid, Sulphuric Acid etc



VERTICAL LIFT

DELIVERS



Upto 200 ml (7 oz.) per stroke

LEVER ACTION

DELIVERS



Upto 60 ml (2 oz.) per stroke

CAT. NR.	ORD. NR.	PUMP TYPE	SUITABLE FOR
VLP/SS/5/F	44131	Vertical Lift	20 -30 Litre (5 gl.) Pails
VLP/SS/55/F	44132	Vertical Lift	50 – 205 Litre (15-55 gl.) Drums
LLP/SS/5/F	44147	Lever Action	20 -30 Litre (5 gl.) Pails
LLP/SS/55/F	44148	Lever Action	50 – 205 Litre (15-55 gl.) Drums



VLP-SS



LLP-SS

Chemical Compatibility Chart

CHEMICALS	COMPATIBILITY
Acetaldehyde	Excellent
Acetic acid 20%	Excellent
Acetone	Excellent
Alcohol: Amyl	Excellent
Alcohol: Benzyl	Good
Alcohol: Diacetone	Excellent
Alcohol: Ethyl	Excellent
Alcohol: Hexyl	Excellent
Alcohol: Isobutyl	Excellent
Alcohol: Methyl	Excellent
Ammonia, anhydrous	Good
Ammonia, liquid	Good
Ammonia: 10%	Excellent
Ammonium Hydroxide	Excellent
Amyl Acetate	Excellent
Anti-freeze	Fair
Benzene	Good
Benzoic Acid	Good
Bleach	Fair
Boric Acid	Excellent
Calcium Chloride (30% in water)	Good
Calcium Hypochlorite	Good
Citric Acid	Excellent
Detergents	Excellent
Diesel Fuel	Excellent
Ethyl Acetate	Good
Ethylene Glycol	Good
Formic Acid	Excellent
Fuel Oils	Good
Gasoline	Excellent
Glycerin	Excellent
Hydrochloric Acid, to 37%	Bad
Hydrogen Peroxide, to 30%	Good
Jet Fuel (JP3: JP4: JP5)	Excellent

CHEMICALS	COMPATIBILITY
Kerosene	Excellent
Lacquer Thinners	Excellent
Lacquers	Excellent
Lactic Acid	Good
Methyl Ethyl Ketone	Excellent
Mineral Spirits	Excellent
Naphtha	Good
Nitric Acid, to 20%	Excellent
Oxalic Acid, (Cold)	Excellent
Phenol	Good
Phosphoric Acid, to 40% solution	Fair
Photographic (developer)	Excellent
Potassium Chloride	Excellent
Potassium Hydroxide	Excellent
Potassium Sulfate	Excellent
Propylene Glycol	Good
Silicone	Excellent
Sodium Bicarbonate (Baking Soda)	Excellent
Sodium Carbonate (Soda Ash)	Excellent
Sodium Chloride	Good
Sodium Hydroxide 50% (Caustic Soda)	Good
Sodium Nitrate	Good
Sodium Sulfate	Good
Stoddard Solvent	Excellent
Sulfuric Acid, 75%	Bad
Toluene, Toluol	Excellent
Trichlorethylene	Good
Tricochlorethane	Good
Turpentine	Excellent
Urea/DEF/Adblue	Good
Water	Excellent
Xylene	Good

DISCLAIMER

The information in this chart is to be used ONLY as a guide in selecting equipment for appropriate chemical compatibility. Before permanent installation, test the equipment with the chemicals and under the specific conditions of your application.

We do not warrant (neither express nor implied) that the information in this chart is accurate or complete or that any material is suitable for any purpose.

Variations in chemical behavior during handling due to factors such as temperature pressure, and concentrations can cause equipment to fail.

The compatibility shown in the chart is based on 22°C (72°F)

142



142

143



143

144



AIR LINE

accessories

Superior
performance
solutions between
the compressor and
your tool.

128

AIR REGULATOR

R13

Maintains steady outlet pressure, unaffected by variations / fluctuations in the inlet pressure

Aluminum die cast construction with a non raising "Press to Lock" adjusting knob for locking at any set pressure

Can be installed in any position (horizontal / vertical)

Supplied complete with pressure gauge & wall mounting bracket



Max. Pressure
220 PSI (15 BAR)



Maximum Flow Rate	600 LPM (21 CFM)
Pressure Adjustment Range	7 to 145 PSI (0.5 to 10 BAR)

CAT. NR.	ORD. NR.	CAT. NR.	ORD. NR.	DESCRIPTION	INLET / OUTLET PORT SIZE	PRESSURE GAUGE PORT SIZE
BSP		NPT				
R13614/GB	60021	R13914/GB	60071	Miniature	1/4"	1/8"

129

AIR LUBRICATOR

L13

Used to feed lubricants to air operated equipment, these maintain a constant oil-to-air density over a wide range of flow

Fog/Micro Mist type, upto 50' pipe runs

Aluminum die cast head fitted with oil drop indicator, oil drop controller & oil filling plug
Polycarbonate bowl & steel bowl guard

Supplied complete with wall mounting bracket



Max. Pressure
145 PSI (10 BAR)

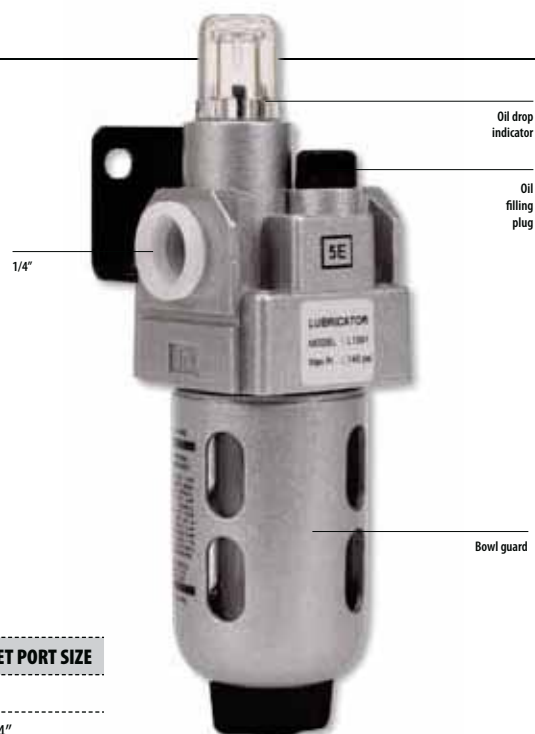

Minimum Flow Rate	12 LPM (0.42 CFM)
Maximum Flow Rate	1350 LPM (48 CFM)

CAT. NR.	ORD. NR.	CAT. NR.	ORD. NR.	DESCRIPTION	INLET / OUTLET PORT SIZE
BSP		NPT			
L1361/B	60211	L1391/B	60261	Miniature	1/4"

130

FILTER REGULATOR COMBINATION

FRC13

Compact Combination unit for removing contaminants & moisture from compressed air in addition to regulating air pressure

Regulator has a non raising "Press to Lock" adjusting knob for locking at any set pressure

Filter is designed with a separator & shield for efficient moisture separation.
Supplied complete with pressure gauge & wall mounting bracket

Maximum Flow Rate	550 LPM (20 CFM)
Pressure Adjustment Range	7 to 145 PSI (0.5 to 10 BAR)
Filtering Element	Sintered Bronze (40 micron)
Drain Type	Semi Automatic

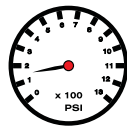

**Max. Pressure
145 PSI (10 BAR)**

1/4"



Bowl guard

Semi automatic drain

CAT. NR.	ORD. NR.	CAT. NR.	ORD. NR.	DESCRIPTION	INLET / OUTLET PORT SIZE	PRESSURE GAUGE PORT SIZE
BSP		NPT				
FRC136134-S/GB	60322	FRC139134-S/GB	60372	Miniature	1/4"	1/8"

131

FILTER - REGULATOR & LUBRICATOR - 2PC

FRCLM13

Space saving 2 pc Modular Filter-Regulator combination & lubricator

Filter removes contaminants & moisture from compressed air

Regulator has a non raising "Press to Lock" adjusting knob for locking at any set pressure

Lubricator feeds lubricants to air operated equipment maintaining a constant oil-to-air density over a wide range of flow

Supplied complete with pressure gauge & wall mounting bracket

Minimum Flow Rate	12 LPM (0.42 CFM)
Maximum Flow Rate	500 LPM (18 CFM)
Pressure Adjustment Range	7 to 145 PSI (0.5 to 10 BAR)
Filtering Element	Sintered Bronze (40 micron)
Drain Type	Semi Automatic



**Max. Pressure
145 PSI (10 BAR)**

1/4"



Oil drop indicator

Oil filling plug

1/4"

Semi automatic drain

CAT. NR.	ORD. NR.	CAT. NR.	ORD. NR.	DESCRIPTION	INLET / OUTLET PORT SIZE	PRESSURE GAUGE PORT SIZE
BSP		NPT				
FRCLM136134-S/G	60405	FRCLM139134-S/G	60455	Miniature	1/4"	1/8"

132

AIR COUPLER & NIPPLE

For instantaneous coupling of grease guns, impact wrenches, paint sprayers & other air operated equipment

Positive action locking mechanism ensures that coupler cannot be disengaged accidentally

Unique Coupler design allows coupler & nipple to be joined together without the need to pull back sleeve

Extra large air passage ensures greater air flow

Automatic air check valve shuts off air instantly when disengaged, providing leak proof seal

Extra long stem of AN/1-4/N nipple & coupler body ensures long service life & easy connections under severe operating conditions

Heavy Duty Steel construction
Threaded 1/4" NPT



Max. Pressure
250 PSI (17 BAR)

QCA/1-4/N



AN/1-4/N

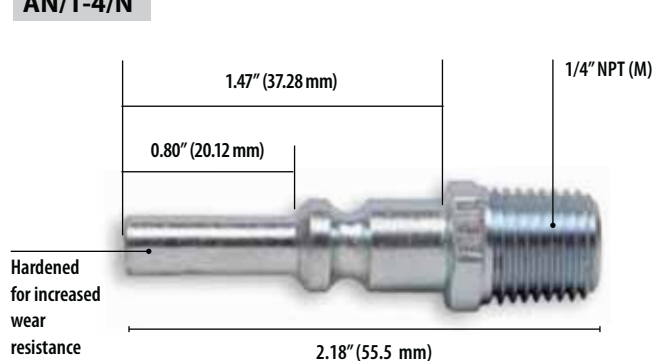

AN/1-4F/N

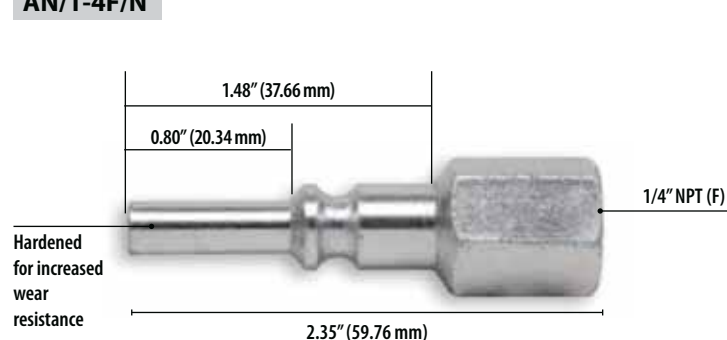

IV/PGG



CAT. NR.	ORD. NR.	TYPE	THREADS
QCA/1-4F/N	60700	Air Coupler	1/4" NPT (F)
AN/1-4/N	60701	Nipple for Air coupler	1/4" NPT (M)
◆ AN/1-4F/N	60705	Nipple for Air coupler	1/4" NPT (F)
● IV/PGG	60702	Universal Air Nipple	1/4" NPT (M)

Key ◆ New ● Standard on all Groz Air Operated Grease Guns

All Steel construction

Used to connect Air Control Units to Air Inlet port on equipment

Threaded 1/4" (M) x 1/4" (M)

Standard accessory on all Groz GP and OP series Air Operated Pumps

NPL/KP71/K63



NPL/RP/N



CAT. NR.	ORD. NR.	THREADS
NPL/KP71/K63	60704	1/4" BSP (M)
NPL/RP/N	60703	1/4" NPT (M)

146



147



148



DRUM

handling

Safe, strong & durable
platforms on castors

NEW PRODUCTS

to look out for

146 DRUM DOLLY - STAINLESS STEEL

147 BAND DOLLIES

148 CROSS BRACE LIP DOLLY

134

DRUM DOLLY

BDL-140

Extra heavy duty drum dolly for conveniently moving 205 litre (55 gallon) drums in shop floors & rough workshop environment

Heavy 3 mm (11 gauge) steel sheet construction

Design incorporates wide steel cross bases for full base support

Firmly welded 4 heavy duty castors

Overall Height

6.1/2" (165 mm)

Powder coated finish

Available with a choice of solid cast iron wheels 3" (75 mm) dia. X 1.3/8"(35 mm) wide or phenolic wheels 3" (75 mm) dia. X 1.1/4" (32 mm) wide

Holds drums of diameter 23" (584 mm)



CAT. NR.	ORD. NR.	CASTORS	CAPACITY
BDL/140	44379	Phenolic	400 kg (900 lbs)
* BDL/140S	44373	Cast Iron	545 kg (1200 lbs)

Key * Best Seller

135

DRUM DOLLY - STAINLESS STEEL

NEW!

BDL-140SS

Stainless steel drum dollies are ideal for use in clean room, pharmaceutical, food, marine & wash down applications

For conveniently moving 205 litre (55 gallon) drums

These have welded construction & are made from 304 Stainless Steel

Design incorporates wide cross brace for full base support 4 welded swivel castors 3" (75 mm) dia. X 1-1/4" (32 mm)wide, use SS bracket & nylon wheels

Overall Height

6-1/2" (165 mm)

Suitable for drums of diameter 23" (584 mm)



CAT NR.	ORD. NR.	CASTORS	CAPACITY
BDL/140SS/N	44355	Nylon	500 kg (1100 lbs)

136

BAND DOLLIES

BDL-105

BDL-60

BDL-120

BDL-130



BDL-120S

BDL-130S



Heavy Duty Drum Dollies with welded 3 mm (11 gauge) steel sheet construction

Design incorporates strong steel braces

Removable castor design with a choice of phenolic or cast iron castors
2-13/32" (61 mm) dia. x 27/32" (21 mm) wide for use in rough workshop environment

Adjustable clamping bolt design allows the dolly to be adjusted easily for varying barrel/ pail diameters

Fully powder coated finish



BDL-105

4 phenolic wheels for moving 25-50 lbs / 20 kg / 5 gallon drums. Holds drums with dia. 10-1/4" to 11-9/32" (260 to 287 mm)



BDL-60

4 phenolic wheel castors. For moving 132 lbs / 60 kg / 19 gallon drums. Holds drums with dia. 15" to 15-3/4" (381 to 400 mm)



BDL-120

4 phenolic wheel castors. For moving 120 lbs / 50 kg / 16 gallon / drums. Holds drums with dia. 13.1/2" to 14.1/4" (343 to 362 mm)



BDL-120S

4 phenolic wheel castors. For moving 120 lbs / 50 kg / 16 gallon / drums. Holds drums with dia. 13.1/2" to 14.1/4" (343 to 362 mm)



BDL-130

5 phenolic wheel castors. For moving 30 gal. containers. Holds drums with dia. 18" to 19" (457 to 482 mm)



BDL-130S

5 cast iron castors. For moving 30 gal. containers. Holds drums with dia. 18" to 19" (457 to 482 mm)

CAT. NR.	ORD. NR.	SUITABLE FOR	DIA. RANGE	CASTORS	CAPACITY
BDL/105	44369	25-50 lb / 20 kg / 5 gal. containers	10-1/4" to 11.9/32" (260 to 287 mm)	Phenolic (4)	90 kg (200 lbs.)
* BDL/120	44371	120 lb / 50 kg / 16 gal. containers	13.1/2" to 14.1/4" (343 to 362 mm)	Phenolic (4)	90 kg (200 lbs.)
* BDL/120S	44372	120 lb / 50 kg / 16 gal. containers	13.1/2" to 14.1/4" (343 to 362 mm)	Cast Iron (4)	136 kg (300 lbs.)
BDL/60	44398	132 lb / 60 kg / 19 gal. drums	15" to 15.3/4" (381 to 400 mm)	Phenolic (4)	90 kg (200 lbs.)
BDL/130	44356	30 gal. containers	18" to 19" (457 to 482 mm)	Phenolic (5)	114 kg (250 lbs.)
BDL/130S	44357	30 gal. containers	18" to 19" (457 to 482 mm)	Cast Iron (5)	170 kg (75 lbs.)

Key * Best Seller

137

CROSS BRACE LIP DOLLY

NEW!

BDL-138

Cross Brace Drum Dolly ,
constructed from 3 mm
(11 gauge) steel sheet

**Not only do these transport
round 205 Litre (55 gal.)
drums, but also capable of
handling square cartons &
crates**

Bolted castor design with 4
heavy duty Phenolic wheel
castors 3" (76 mm) dia. X 1-1/4"
(32 mm) wide

Holds drums of diameter 23"
(584 mm)

Unit comes flat packed in
knocked down condition in a
compact box , offering great
saving on space

Fully powder coated finish

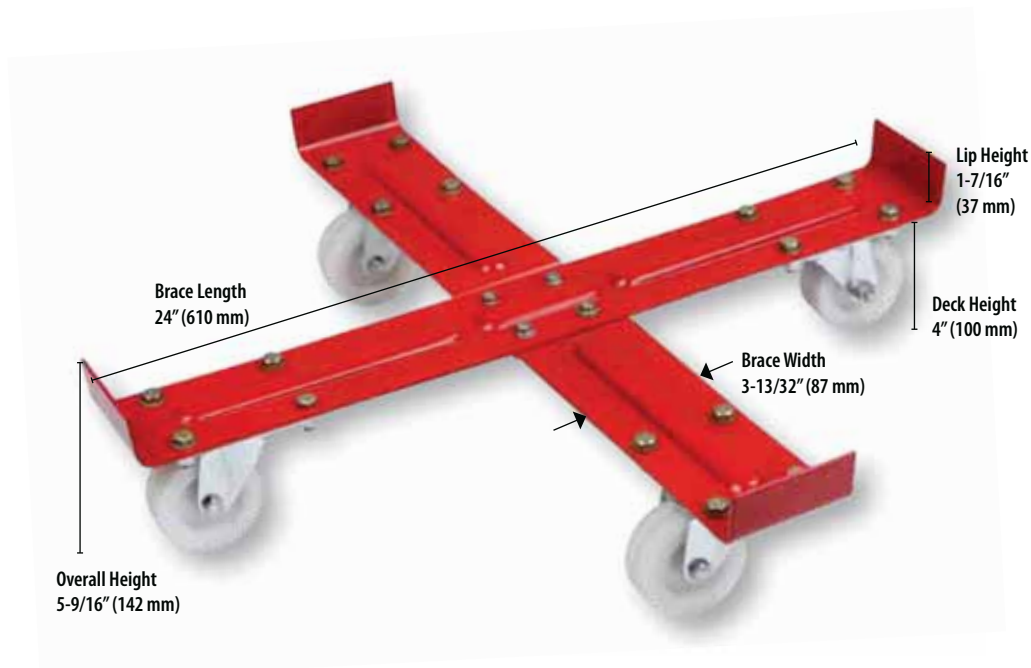

CAT. NR.	ORD. NR.	CASTORS	CAPACITY
BDL/138	48000	Phenolic	400 kg (900 lbs.)

138

DRUM WRENCH

DRW

An easy & convenient tool
to open almost all types of
drums

Ends of the wrench are
designed to fit perfectly
onto most 2" & 3/4" drum
plugs

Wrench is manufactured
from cast aluminum
(LM25), hardened &
tempered for increased
strength
Compact design for easy
storage



CAT. NR.	ORD. NR.
* DRW/AL-01	44385

Key * Best Seller

139

DRUM CRADLE

NEW!

DRC-133

DRC-135

DRC-137

Tilting Drum Cradle tips, rotates, moves & stores 400 lbs / 180 kg / 205 litre / 55 gallon drums

Equipped with self storing lever bar

Large 2-1/2" (63 mm) non-sparking wheels make it suitable for use in flammable environments

Maximum load 600 lbs / 273 kgs

Fully powder coated finish

Unit comes flat packed in semi-knocked down condition for ease of transport



JUST TIP

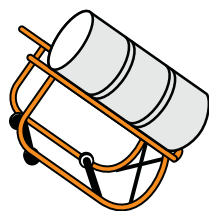

TILT

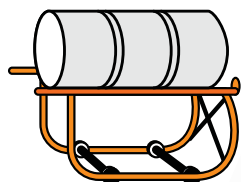

DRAIN



DRC-135

Movable style, complete with wheels



DRC-137

Stationary style, supplied without axles & wheels

DRC-133

Movable style with 2 rigid & 2 swivel wheels



CAT. NR.	ORD. NR.	TYPE
DRC/133	44367	Drum Cradle with axle, 2 rigid & 2 swivel wheels
* DRC/135	44374	Drum Cradle with axle & 4 rigid wheels
DRC/137	44375	Drum Cradle without axle & wheels

Key * Best Seller

140

LOW PROFILE DRUM TROLLEY

TRL-55

Low Profile Drum Trolley with Drum Platform only ½" (12 mm) off the floor, facilitating easy loading & unloading

Designed to conveniently move 205 litre (55 gallon) drums of all types

Trolley can accommodate drums up to a dia. of 26" (660 mm)

Extra heavy duty construction, fabricated from 5 mm (6 gauge) steel sheet, with a loading capacity of 545 kgs (1200 lbs)

Removable pivoting handle includes drum tipper for easy loading

Includes 2 large Phenolic front wheels 5-3/4" dia. (146 mm) x 1-7/8" (47 mm) wide & one back phenolic swivel wheel 3" (75 mm) dia. x 1-3/8" (35 mm) wide

Fully powder coated finish

Unit comes flat packed in semi-knocked down condition for ease of transport



CAT. NR.	ORD. NR.
TRL/55	44396

141

DRUM TROLLEY ADJUSTABLE

TRL/60

TRL/20-60

A choice of 2 Easy to use Drum Trolleys with adjustable mechanism for use with 25-50lbs / 5 gallon / 20 litre drums, to larger drums up to 120 lbs / 16 gallons / 60 litre capacity

Ideal for transporting oil / grease barrels, as well as installing air operated pump assemblies

Steel construction with premium powder coated finish

Heavy Duty wheels for use in rigorous workshop environment

Unit comes flat packed in semi-knocked down condition for ease of transport

Adjustable drum height locking clamp

Drum locking clamp

TRL/60

Adjustment base knobs for holding drums of varying diameters

Rubberized wheels 5" dia. x 1-3/8" wide



TRL/20-60

Drum locking clamp

Large phenolic wheels (4" dia. x 1" wide)

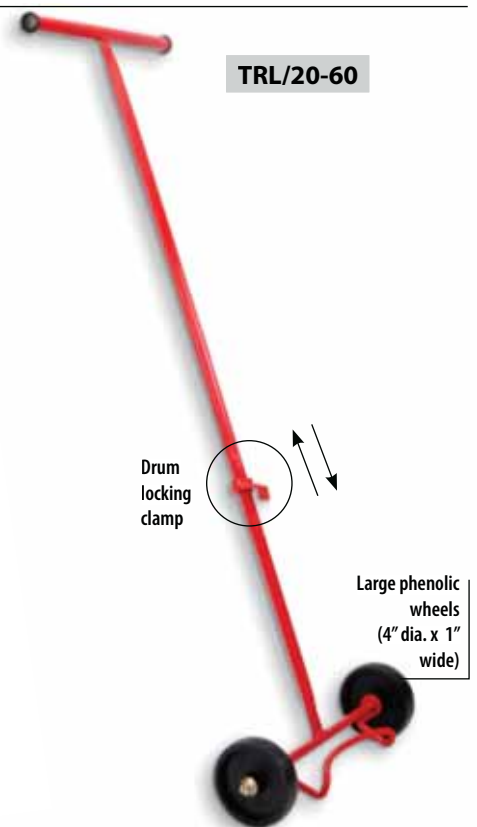

CAT. NR.	ORD. NR.
TRL/60	44377
TRL/20-60	44368

142

DRUM FAUCET / TAP

Polyethylene construction

Fits into 3/4" threaded opening on 205 litre (55 gal.) drums

Facilitates convenient dispensing of media under gravity flow with the drum laid horizontally

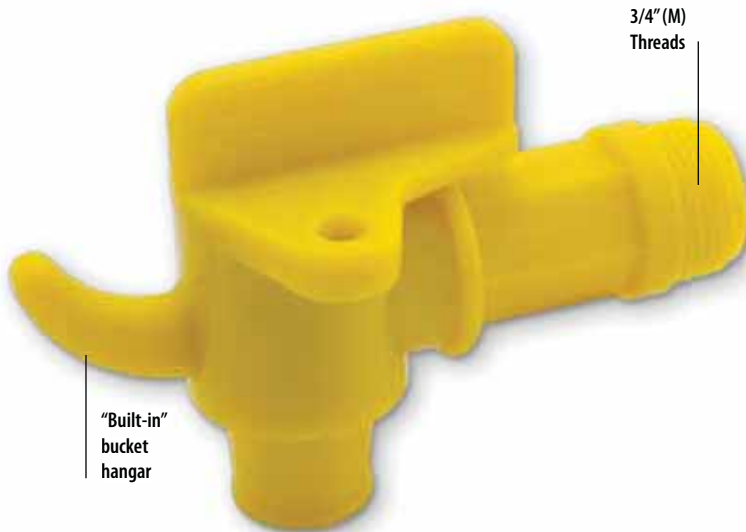

Can be pad locked



CAT. NR.	ORD. NR.
FAU/3-4	44387

143

DRUM BUNG CONVERTER / DRUM BUNGS

Converts 2" fine male threads found on most pumps / drum bungs to 2" male coarse threads. This makes the pump suitable for use on plastic drums with 2" coarse female threads

Polypropylene co polymer construction, designed with 4 protrusions for easy tightening

Dimensions

3-1/4" (82 mm) dia. X 1-35" (34 mm) height

Other sizes can be custom manufactured



2" Fine Threads

2" Coarse Threads

CAT. NR.	ORD. NR.
BUNG/P/2B	44386

ALPHABETIC INDEX

A			
Accessories			
Air operated Oil Pumps	97		
Oil Control Guns	108		
Adaptors			
Female Loader	76		
Grease Adaptors & Elbows	54		
Quick Connect	57		
Quick Disconnect	60		
Air Coupler & Nipple	143		
Air Line Fittings	144		
Air Lubricator	141		
Air Operated Grease Guns	28		
Air Operated Grease Guns - High Power	30		
Air Operated Pumps			
Composite Grease Ratio Pumps 50:1	61		
Composite Oil Ratio Pump 5:1	93		
DEF Transfer	131		
Double Diaphragm	98		
Double Diaphragm Waste Oil	121		
Grease Ratio Pumps 50:1	62		
Oil Ratio Pump	94		
Stainless Steel	96		
Air Regulators	141		
Air Release Valves	46		
Air/Water Hose Reels	118		
B			
Band Dollies	147		
Battery Operated Transfer Pump	136		
Battery Powered Grease Gun	31		
Bearing Packers	47		
Bilge/ Diaphragm Pump	128		
Brass Transfer Pump	137		
Bucket Greasers	70		
Bulk Loaders/ Filler Nipples	46		
Bung Converter - drum	151		
Bung Nuts	91		
Button Head Coupler	36		
C			
Clear Tube Lever Grease Gun	24		
Clear Tube Pistol Grip Grease Gun	25		
Control Valves - Grease			
Boosters	65		
Metered	66		
Professional	64		
Control Gun - Oil	107		
Control Gun - Electronic	104		
Control Gun - Mechanical	105		
Control Gun - Electronic Preset	106		
Control Gun - Oil, Accessories	108		
Couplers			
Air Coupler	143		
Button Head Couplers	36		
Heavy Duty	34		
Hydraulic Couplers & Sets	32		
Hydraulic Coupler 360° Swivel	35		
Hydraulic Coupler 90°	35		
Hydraulic Coupler Air-O	34		
Pin Type	37		
Professional	32		
Professional - Slim	32		
Standard	32		
Cross Brace Lip Dolly	148		
D			
DEF Transfer Pumps - Air Operated	131		
Diaphragm / Bilge Pump	128		
Diaphragm Pump - Food Grade	129		
Dispensers			
Needle Nose	37		
Seal Off	38		
Double Diaphragm Fuel Transfer Pump	85		
Double Lever Grease Gun	14		
Drip Pans	91		
"Drive Fit" Grease Fitting Installer	56		
Drum Bung Converter	151		
Drum Cradle	149		
Drum Dolly	146		
Drum Dolly - Cross Brace	148		
Drum Dolly - Stainless Steel	146		
Drum Faucets	151		
Drum Trolley - Adjustable	150		
Drum Trolley - Low Profile	150		
Drum Wrench (Drum Opener)	148		
Dual Discharge Pistol Grip Grease Gun	17		
E			
Easy Out Tools	55		
Elbows - Grease	54		
Electric Oil & Fuel Pump	100		
Electric Oil Pump	124		
Electronic Oil Control Gun	105		
Electronic Oil Meter	102		
Electronic Preset Oil Control Gun	106		
Extensions - Grease Gun			
Flexible / Rigid	44		
Steel Extensions	45		
Swivel	44		
Ezee - Lube Kit	60		
Ezee Flow Pumps	90		
F			
Faucets	151		
Feeders - Grease	48		
Female Loader Adaptors	76		
Filler Nipples/ Bulk Loaders	46		
Filter - Regulator & Lubricator - 2 pc	142		
Filter Regulator Combination	142		
Fitting - Air Line	144		
Fitting - Grease	50		
Flexible & Rigid Spouts	114		
Flexible /Rigid Grease Gun Extension	44		
Flexible Spout Measures	115		
Follower Plates	75		
Foot operated Grease Pump	68		
Funnels	116		
G			
Grease Adaptors & Elbows	54		
Grease Control Valves			
Metered	66		
Professional	64		
Booster	65		
Grease Fittings	50		
Grease Fitting Sets	52		
Grease Fitting Caps	55		
Grease Fitting Installer - Drive Fit	56		
Grease Fitting Thread Tester	54		
Grease Fitting Unblocker	56		
Grease Guns			
Air Operated Grease Guns	28		
Battery Powered Grease Guns	31		
Clear Tube Pistol Grip Grease Gun	25		
Double lever Grease Gun	14		
Dual Discharge Pistol Grip Grease gun	17		
High Power Air Operated Grease Gun	30		
Lever grease Gun - Clear Tube	24		
Lever Grease Gun - Heavy Duty	6		
Lever Grease Gun - Japanese Style	13		
Lever Grease Gun - Professional	8		
Lever Grease Gun - Standard	10		

Lever Grease Gun - Super Value	9
Lever Oil Gun	12
Mini Lever Grease Gun	26
Mini Pistol Grease Gun - Deluxe	27
Mini Pistol Grease Gun - Popular	27
Pistol Grip Grease Gun	20
Pistol Grip Grease Gun - Professional	15
Push Type Grease Guns	26
Quick Connect Pistol Grip Grease Gun	22
'V' Series Lever Grease Gun	11
'V' Series Pistol Grip Grease Gun	21
'Vario' Premium Pistol Grip Grease Gun	16
Ultimate All Weather Pistol grip Grease Gun	18
Grease Gun Extension	
Flexible / Rigid	44
Steel Extension	45
Swivel	44
Grease Gun Holders	39
Grease Gun Holder - Heavy Duty	39
Grease Gun Light	45
Grease Hoses	
Flexible	40
Heavy Duty	42
Grease Hose Reels	118
Grease Feeders	48
Grease Injector Needle	38
Grease Pumps	
Bucket Greasers	70
Foot Operated Grease Pumps	68
Grease Filler Pump	73
Grease Filler Pump - Professional	72
Grease Ratio Pump 50:1	62
Grease Ratio Pump 50:1, Composite	61
High Pressure	74
Portable Greasing System	69
Grease Swivels - High Pressure	67
H	
Holder - Grease Gun	39
Hoses, Grease	
Flexible	40
Heavy Duty	42
Hose Reels	
Air/Water	118
Grease	118
Oil	118
Hydraulic Couplers	

Button Head Couplers	36
Heavy Duty	34
Hydraulic Coupler 360° Swivel	35
Hydraulic Coupler 90°	35
Hydraulic Coupler Air-O	34
Pin Type	37
Professional	32
Professional - slim	32
Standard	32

I

Industrial Rotary Barrel Pumps	96
Injector Needles - Grease	38

J

Japanese Style - Lever Grease Gun	13
-----------------------------------	----

L

Lever Action Barrel pump	78
Lever Oil Gun	12
Light - Grease Gun	45
Litre/Quart Stroke Pump	81
Low Profile Truck Drains	125
Lubricator - Air	141

M

Measures - Flexible Spout	115
Mechanical Oil Control Gun	105
Mechanical Oil Meter	103

N

Needle Nose Dispensers	37
------------------------	----

O

Oil Cans	112
Oil Cans - Speciality	114
Oil Meters	
Electronic	102
Mechanical	103
Oil Control Gun	
Electronic	104
Electronic preset	106
Mechanical	105
Oil Guns	107

Oil Control Gun Accessories	108
Oil Lube Dispenser	88
Oil Spigot	109
Oil Gun - Lever Type	12
Oil Hose Reels	118
Oil Drain Pans	126

P

Plastic Rotary Pumps	132
Pumps - Fuel	
Double Diaphragm Fuel Transfer Pump	85
Industrial Rotary Fuel Pumps	86
Rotary Booster 3:1	84
Pumps - Grease	
Bucket Greasers	70
Composite Air Operated 50:1	61
Filler Pump	73
Filler Pump - Professional	72
Foot Operated	68
Grease Ratio 50:1	62
High Pressure	74
Portable Greasing System	69
Pumps - Oil	
5:1 Composite Air Operated	93
Air Operated Double Diaphragm	98
Air operated Double Diphragm Waste Oil	121
Air Operated Ratio Pumps	94
Air Operated Stainless Steel	96
Double Diaphragm Fuel Transfer Pump	85
Electric Oil & Fuel Pump	100
Electric Oil Pump	124
Ezee Flo Pumps	90
Front Action Barrel Pump	80
Lever Action Barrel Pump	78
Lever Action Oil Pump	79
Oil Lube Dispenser	88
Quart / Litre Stoke Pump	81
Rotary Barrel Pumps	82
Rotary Barrel Pumps - Industrial	86
Rotary Barrel Pumps - Professional	83
Rotary Booster 3:1	84
Spring Loaded Pumps	89
Vertical Lift Pump	79
Pumps - Special Application	
Air Operated DEF Transfer Pump	131
Battery operated Transfer Pump	136
Brass Transfer Pump	137
Diaphragm / Bilge Pump	128

ALPHABETIC INDEX (continued)

Diaphragm Pump - Food Grade	129
Nylon Chemical Pump	134
Plastic Lever Pump	130
Plastic Rotary Pump	132
Polypropylene Chemical Pump	134
Safety Pump	138
Siphon Pumps	135
Tire Sealant Pump	136
Push Type Grease Guns	26

Q

Quart Stroke Pump	81
Quick Connect Adaptors	57
Quick Connect Pistol Grip Grease Gun	22
Quick Disconnect Adaptors	60

R

Regulator - Air	141
Rigid & Flexible Spouts	114
Rotary Barrel Pump	82
Rotary Barrel Pumps - Industrial	86
Rotary Barrel Pump - Professional	83
Rotary Booster Pump 3:1	84
Rotary pump - Plastic	132

S

Safety Pumps	138
Seal Off Dispensers	38
Siphon Pumps	135
Smart Funnels	116
Speciality Oil Cans	114
Spouts - Flexible & Rigid	114
Spring Loaded Pumps	89
Suction Gun	110
Suction Tubes	92
Swivel - Grease - Straight, 90°, Z	67
Swivel - Grease Gun Extension	44

T

Thread Tester	54
Tire Sealant Pump	136
Transfer Gun	111
Transfer Pumps - Brass	137

U

Ultimate All Weather Pistol grip Grease Gun	18
Universal Air Nipple	143

V

Valves - Grease Control	
Booster	65
Metered	66
Professional	64
Vertical Lift Pump	79

W

Waste Oil Air Operated Double Diaphragm Pump	121
Waste Oil Drain - Gravity Feed	123
Waste Oil Drain - Pressuried	122
Waste Oil Drain Pans	126

Whilst every effort has been made to ensure accuracy of information given in this catalogue at the time of going to print, Sept 2014, our policy of continuous improvement determines the right to change specifications without notice. Customers must ensure that goods are suitable for the purpose intended.

NUMERICAL INDEX

Ord. No.	Page No.	Ord. No.	Page No.	Ord. No.	Page No.	Ord. No.	Page No.	Ord. No.	Page No.
41205	114	41802	114	42421	10	42747	12	43062	15
41206	114	41810	112	42422	10	42750	7	43063	15
41207	114	41811	112	42430	10	42751	7	43070	20
41208	114	41815	112	42431	10	42752	7	43071	20
41209	114	41816	112	42432	10	42760	7	43072	20
41224	114	41820	112	42440	10	42761	7	43080	20
41225	114	41821	112	42441	10	42762	7	43085	20
41226	114	41825	112	42442	10	42780	7	43088	16
41227	114	41826	112	42450	10	42785	7	43095	16
41229	114	41900	115	42451	10	42790	13	43096	16
41410	112	41901	115	42452	10	42795	14	43098	16
41411	112	41902	115	42470	10	42796	14	43100	26
41412	112	41903	115	42471	10	42900	11	43101	26
41413	112	41904	115	42472	10	42901	11	43200	27
41414	112	41920	116	42500	9	42902	11	43201	27
41415	112	41921	116	42501	9	42920	11	43202	27
41420	112	41922	116	42502	9	42921	11	43250	27
41421	112	41960	126	42520	9	42922	11	43251	27
41422	112	41961	126	42521	9	42950	21	43252	27
41423	112	42220	112	42522	9	42951	21	43260	27
41424	112	42221	112	42560	9	42952	21	43261	27
41425	112	42222	112	42561	9	42970	21	43262	27
41430	112	42223	112	42565	9	42971	21	43280	26
41431	112	42225	112	42566	9	42972	21	43281	26
41432	112	42226	112	42580	9	43000	20	43282	26
41433	112	42227	112	42585	9	43001	20	43300	28
41434	112	42228	112	42590	9	43002	20	43301	28
41435	112	42230	112	42591	9	43015	17	43302	28
41610	112	42231	112	42595	9	43016	17	43303	28
41611	112	42232	112	42596	9	43017	17	43304	28
41612	112	42233	112	42600	8	43020	20	43305	28
41613	112	42240	112	42601	8	43021	20	43320	28
41614	112	42241	112	42602	8	43022	20	43321	28
41615	112	42242	112	42620	8	43040	18	43322	28
41620	112	42243	112	42621	8	43041	18	43323	28
41621	112	42245	112	42622	8	43042	18	43324	28
41622	112	42246	112	42700	7	43043	22	43325	28
41623	112	42247	112	42701	7	43044	22	43360	30
41624	112	42248	112	42702	7	43045	18	43361	30
41625	112	42250	112	42720	7	43046	18	43362	30
41630	112	42251	112	42721	7	43047	18	43370	30
41631	112	42252	112	42722	7	43048	18	43371	30
41632	112	42253	112	42740	12	43049	22	43372	30
41633	112	42400	10	42741	12	43050	20	43380	28
41634	112	42401	10	42742	12	43051	20	43381	28
41635	112	42402	10	42745	12	43052	20	43385	28
41801	114	42420	10	42746	12	43061	15	43389	28

NUMERICAL INDEX

Ord. No.	Page No.	Ord. No.	Page No.	Ord. No.	Page No.	Ord. No.	Page No.	Ord. No.	Page No.
43400	64	43520	34	43610	40	43760	42	44031	83
43401	64	43521	34	43611	40	43761	42	44032	83
43402	64	43522	34	43612	40	43770	42	44050	82
43403	64	43523	34	43613	40	43771	42	44052	82
43404	64	43524	34	43614	40	43780	42	44058	82
43415	66	43525	34	43615	40	43781	42	44059	82
43416	66	43530	37	43616	40	43800	67	44064	82
43420	64	43531	37	43620	40	43801	67	44075	91
43421	64	43532	37	43621	40	43802	67	44076	91
43422	64	43535	32	43622	40	43803	67	44080	86
43423	64	43536	32	43623	40	43804	67	44081	86
43424	64	43537	32	43624	40	43810	67	44082	86
43450	65	43540	34	43625	40	43811	67	44083	86
43451	65	43541	34	43626	40	43812	67	44084	86
43452	65	43542	34	43630	40	43813	67	44086	86
43453	65	43550	35	43631	40	43814	67	44092	82
43454	65	43551	35	43640	40	43820	67	44100	78
43460	65	43552	35	43641	40	43821	67	44110	80
43461	65	43560	35	43650	40	43822	67	44116	79
43462	65	43561	35	43651	40	43823	67	44120	78
43463	65	43562	35	43660	40	43824	67	44125	78
43464	65	43565	36	43661	40	43825	67	44130	79
43465	65	43566	36	43670	40	43890	108	44131	138
43466	65	43567	36	43671	40	43891	108	44132	138
43467	65	43570	36	43680	40	43895	108	44135	89
43468	65	43572	36	43681	40	43896	108	44144	132
43469	65	43574	36	43685	40	43900	50	44145	132
43470	65	43576	36	43686	40	43901	50	44147	138
43471	65	43577	36	43687	40	43902	50	44148	138
43472	65	43578	36	43688	40	43903	50	44150	88
43473	65	43579	36	43689	40	43970	52	44160	88
43474	65	43581	32	43690	40	43971	52	44166	130
43500	32	43582	32	43700	42	43972	52	44167	130
43501	32	43583	32	43701	42	43973	52	44180	88
43502	32	43584	32	43702	42	43976	52	44181	88
43503	32	43585	32	43710	42	43977	52	44183	90
43504	32	43586	32	43711	42	43978	52	44185	130
43505	32	43590	32	43712	42	43979	52	44186	134
43507	32	43591	32	43720	42	43980	52	44187	81
43508	32	43592	32	43721	42	43981	52	44191	132
43509	32	43600	40	43722	42	43982	52	44192	134
43510	32	43601	40	43730	42	43983	52	44193	134
43511	32	43602	40	43731	42	43984	52	44194	85
43512	32	43603	40	43740	42	43985	52	44195	85
43516	32	43604	40	43741	42	43986	52	44196	132
43517	32	43605	40	43750	42	44000	82	44198	84
43518	32	43606	40	43751	42	44030	83	44199	136

Ord. No.	Page No.	Ord. No.	Page No.	Ord. No.	Page No.	Ord. No.	Page No.	Ord. No.	Page No.
44200	73	44338	85	44520	137	44853	37	45035	108
44201	84	44338	86	44521	137	44854	37	45200	110
44210	73	44339	83	44601	122	44860	37	45205	110
44211	73	44340	88	44610	123	44861	37	45220	110
44212	73	44342	110	44611	123	44862	37	45250	111
44215	72	44343	111	44710	98	44870	38	45310	93
44216	72	44345	74	44720	98	44871	38	45311	93
44220	73	44346	62	44720	121	44872	38	45315	131
44221	73	44350	109	44721	98	44875	57	45316	131
44222	73	44351	109	44722	98	44879	38	45320	94
44230	74	44352	109	44730	98	44880	38	45321	94
44231	74	44352	109	44730	121	44881	38	45322	94
44245	74	44355	146	44731	98	44882	38	45323	94
44250	69	44356	147	44740	98	44885	44	45324	94
44255	68	44357	147	44740	121	44886	44	45325	94
44280	70	44360	76	44800	45	44887	44	45330	94
44281	70	44361	76	44801	45	44890	55	45331	94
44282	70	44367	149	44802	45	44891	55	45332	94
44290	70	44368	150	44804	45	44892	56	45333	94
44291	70	44369	147	44809	45	44893	56	45334	94
44292	70	44371	147	44810	44	44894	56	45335	94
44293	70	44372	147	44811	44	44895	54	45340	94
44300	92	44373	146	44812	44	44897	46	45341	94
44301	92	44374	149	44817	45	44898	46	45342	94
44302	92	44375	149	44820	45	44899	46	45343	94
44303	92	44377	150	44821	45	44900	60	45344	94
44304	92	44379	146	44822	45	44901	60	45345	94
44305	92	44380	91	44823	45	44902	57	45355	94
44306	92	44381	91	44827	45	44903	57	45356	94
44308	92	44382	91	44830	46	44904	57	45360	96
44309	92	44383	91	44831	46	44905	57	45365	96
44310	92	44384	91	44833	46	44906	57	45380	97
44311	92	44385	148	44834	46	44907	57	45381	97
44312	92	44386	151	44835	46	44908	57	45382	97
44313	92	44387	151	44836	46	44909	57	45385	97
44320	75	44388	91	44837	46	44910	57	45386	97
44321	75	44396	150	44838	46	44911	57	45387	97
44322	75	44398	147	44839	46	44912	57	45390	97
44323	75	44400	135	44840	39	44913	57	45391	97
44324	75	44401	135	44841	39	44914	57	45392	97
44325	75	44402	135	44842	39	44920	57	45393	97
44326	75	44407	92	44845	47	44921	57	45395	97
44329	75	44410	136	44847	47	44922	57	45396	97
44330	75	44500	128	44848	47	44950	60	45397	97
44331	75	44501	128	44850	37	45010	108	45398	97
44333	75	44502	128	44851	37	45012	108	45400	62
44334	75	44510	129	44852	37	45034	108	45401	62

NUMERICAL INDEX

Ord. No.	Page No.	Ord. No.	Page No.	Ord. No.	Page No.	Ord. No.	Page No.	Ord. No.	Page No.
45402	62	46042	50	46602	50	47255	31	47803	109
45409	61	46044	50	46610	50	47256	31	47804	109
45410	61	46046	50	46611	50	47257	31	47805	109
45411	61	46070	50	46612	50	47400	105	47820	75
45412	61	46071	50	46620	50	47401	105	47821	75
45415	61	46072	50	46630	50	47402	105	47822	75
45416	61	46103	50	46640	50	47403	105	47823	75
45417	61	46104	50	46700	55	47410	105	47824	75
45430	61	46105	50	46701	55	47411	105	47825	75
45431	61	46106	50	46702	55	47412	105	47826	75
45432	61	46113	50	46703	55	47413	105	47829	45
45520	100	46114	50	46704	55	47420	104	47900	118
45521	100	46115	50	46705	55	47421	104	47901	118
45522	100	46116	50	46800	54	47422	104	47902	118
45523	100	46117	50	46801	54	47423	104	47903	118
45550	124	46118	50	46802	54	47460	105	47920	118
45551	124	46200	50	46803	54	47461	105	47921	118
45555	124	46201	50	46804	54	47462	105	47922	118
45556	124	46202	50	46805	54	47463	105	47923	118
45565	124	46220	50	46806	54	47480	104	47960	118
45621	66	46221	50	46900	24	47481	104	47961	118
45715	106	46222	50	46901	24	47482	104	47970	118
45716	106	46223	50	46902	24	47483	104	47971	118
45717	106	46224	50	46903	24	47700	48	47980	118
45718	106	46225	50	46920	25	47701	48	47981	118
45721	107	46230	50	46921	25	47702	48	47990	118
45722	107	46231	50	46922	25	47703	48	47991	118
45730	106	46232	50	46923	25	47704	48	48000	148
45731	106	46240	50	46950	78	47705	48	55015	45
45802	125	46241	50	46990	24	47706	48	60021	141
45803	125	46242	50	46990	25	47707	48	60071	141
46000	50	46300	50	46991	24	47708	48	60211	141
46002	50	46302	50	46991	25	47709	48	60261	141
46003	50	46304	50	47000	102	47720	48	60322	142
46005	50	46400	50	47001	102	47721	48	60372	142
46006	50	46401	50	47050	103	47722	48	60405	142
46020	50	46420	50	47051	103	47723	48	60455	142
46021	50	46421	50	47052	103	47724	48	60700	143
46022	50	46422	50	47200	31	47725	48	60701	143
46023	50	46500	50	47201	31	47726	48	60702	143
46030	50	46501	50	47202	31	47727	48	60703	144
46031	50	46503	50	47203	31	47728	48	60704	144
46032	50	46520	50	47250	31	47729	48	47950	118
46035	50	46521	50	47251	31	47790	48	47951	118
46037	50	46522	50	47252	31	47800	109		
46040	50	46600	50	47253	31	47801	109		
46041	50	46601	50	47254	31	47802	109		

NOTES

A series of horizontal dotted lines for writing notes.

NOTES

A series of horizontal dotted lines for writing notes.